

Zeitplan EWU-Turnier: C Hungen

Veranstaltungstag: **Samstag, 22.04.2017**

Beginn	Prüfung	Prüfungsbezeichnung	Dauer	Ende	Starts
07:00		Öffnung Meldestelle / Freies Abreiten	01:00	08:00	
08:00	LK 3 SSH	Showmanship at Halter	00:25	08:25	8
08:25	LK 2A SSH	Showmanship at Halter	00:15	08:40	5
08:40	LK 1 SSH	Showmanship at Halter	00:20	09:00	7
09:00	LK 1-3 B TH	Trail	00:20	09:20	4
09:20	LK 3A TH	Trail	00:45	10:05	12
10:05	LK 2A TH	Trail	00:35	10:40	10
10:40	LK 1A TH	Trail	00:35	11:15	9
11:15	LK 1-3 B WPL	Western Pleasure	00:15	11:30	5
11:30	LK 3A WPL	Western Pleasure	00:15	11:45	10
11:45	LK 3 WHS	Western Horsemanship	00:40	12:25	16
12:25	Pause	Mittagspause	00:30	12:55	
12:55	Sonderprüfung	SO03 LK 1-3 A/ B RT	00:50	13:55	9
13:55	LK 2A WPL	Western Pleasure	00:20	14:15	7
14:15	LK 2A WHS	Western Horsemanship	00:20	14:35	7
14:35	LK 1A WPL	Western Pleasure	00:15	14:50	8
14:50	LK 1 WHS	Western Horsemanship	00:30		11
anschl.	LK 3 WR	Western Riding	00:20		4
anschl.	LK 1/2 A WR	Western Riding	00:25		6
anschl.	LK 1/2 A sen SUHO	Senior Superhorse	00:35		6
anschl.	LK 1A RR	Ranch Riding	00:25		8
anschl.	LK 1-3 B RR	Ranch Riding	00:15		4
anschl.	LK 2A RR	Ranch Riding	00:25		9
anschl.	LK 3A RR	Ranch Riding	00:35		14
anschl.	LK 3 RN	Reining	00:45		8
anschl.	LK 2A RN	Reining	00:25		4
anschl.	LK 1A RN	Reining	00:35		5

Veranstaltungstag: **Sonntag, 23.04.2017**

Beginn	Prüfung	Prüfungsbezeichnung	Dauer	Ende	Starts
07:00		Öffnung Meldestelle / Freies Abreiten	01:00	08:00	
08:00	LK 4/5 SSH	Showmanship at Halter	00:20	08:20	7
08:20	LK 5A WHS	Western Horsemanship	00:20	08:40	7
08:40	WT Trail	Walk Trot Trail	00:25	09:05	5
09:05	WT Horsemanship	Walk Trot Horsemanship	00:20	09:25	7
09:25	WT Pleasure	Walk Trot Pleasure	00:15	09:40	3
09:40	LK 4B WHS	Western Horsemanship	00:15	09:55	3
09:55	LK 4A WHS	Western Horsemanship	00:35	10:30	14
10:30	LK 4/5 B WPL	Western Pleasure	00:15	10:45	5
10:45	LK 5A WPL	Western Pleasure	00:15	11:00	7
11:00	LK 4A WPL	Western Pleasure	00:30	11:30	14
11:30	FZ	Führzügelklasse	00:15	11:45	7
11:45	Sonderprüfung	Paid Warm Up Trail / Mittagspause	00:45	12:30	8
12:30	LK 4/5 B TH	Trail	00:25		4
anschl.	LK 5A TH	Trail	00:30		6
anschl.	LK 4A TH	Trail	01:05		14
anschl.	Sonderprüfung	SO4 LK 4/5 A RT	00:20		3
anschl.	LK 4/5 B RR	Ranch Riding	00:20		6
anschl.	LK 5A RR	Ranch Riding	00:15		5
anschl.	LK 4A RR	Ranch Riding	00:45		18
anschl.	LK 4 RN	Reining	01:00		14

anschl. **Platzierung Mannschaftswettbewerb**



EWU C Turnier
Hungen
22.-23.04.2017

Reining

LK 1	#8
LK 2	#6
LK 3	#11
LK 4	#14

Senior Superhorse

LK 1/2 A	#4
----------	----

Western Riding

LK 1-3 A/B	#5
------------	----



EWU C Turnier
Hungen
22.-23.04.2017

Showmanship LK 4/5

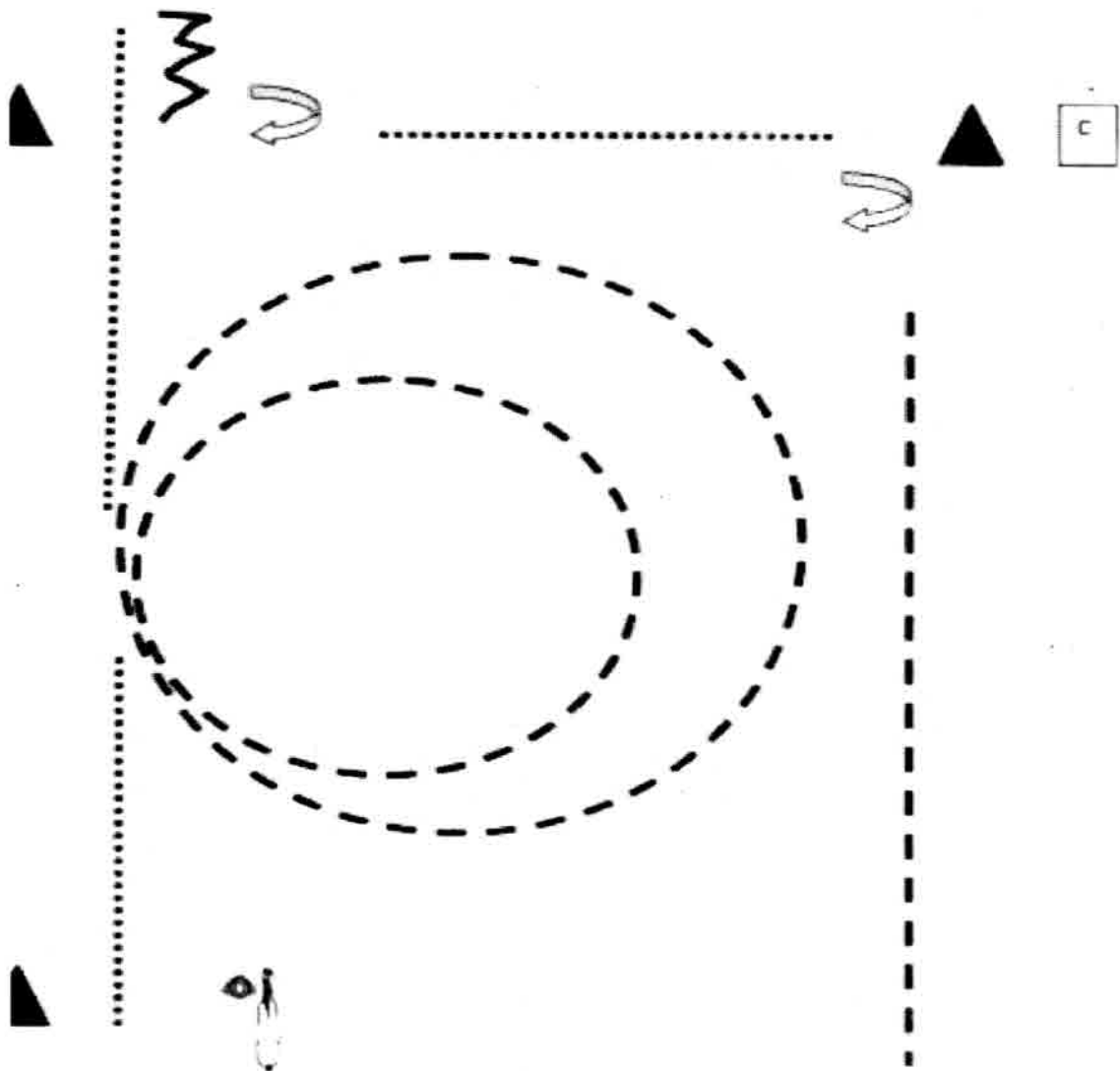

- 1) Bereit halten an der Pylone A. Walk bis ungefähr halben Weg zu B, Jog, Jogvolte klein, Jogvolte groß
- 2) Übergang Walk, Walk, Anhalten hinter Pylone B, Back up,
- 3) 90 Grad HHW rechts, Walk zur Pylone, Anhalten
- 4) Set up zur Inspektion,
Abwenden, im Jog Bahn verlassen –kein Stopp-



EWU C Turnier
Hungen
22.-23.04.2017

Showmanship LK 3

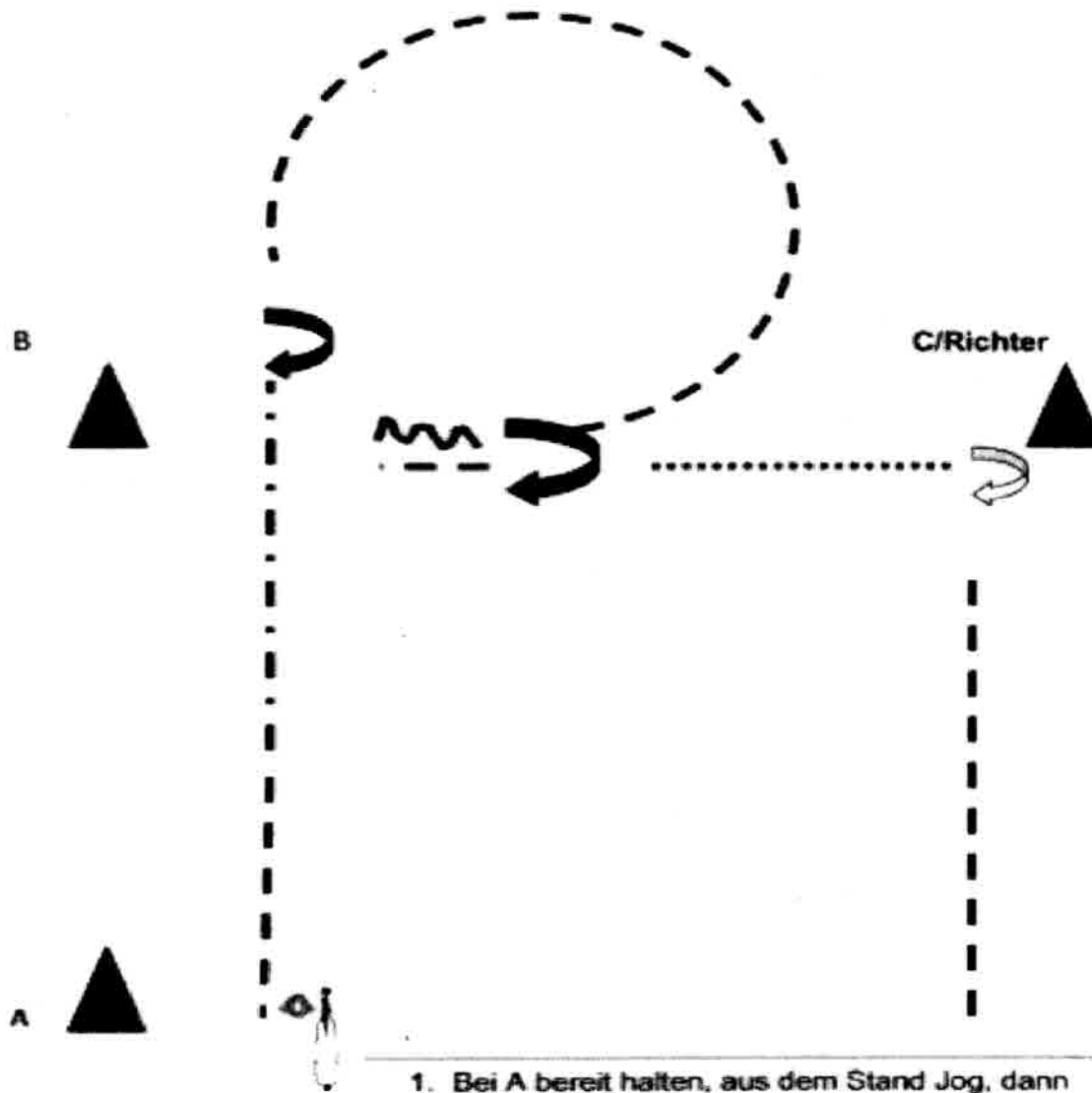

1. Bei A bereit halten, aus dem Stand Jog, dann extended Jog zu B, Stopp hinter B.
 2. 360 Grad HHW rechts, Jog
 3. Jogvolle, Stopp, Back up
 4. 180 Grad HHW rechts, Walk zum Richter, Anha
 5. Set up zur Inspektion
- 90 Grad HHW rechts, Jog, Jog out- kein Stop-Zur warm up area



EWU C Turnier
Hungen
22.-23.04.2017

Showmanship LK 2 A

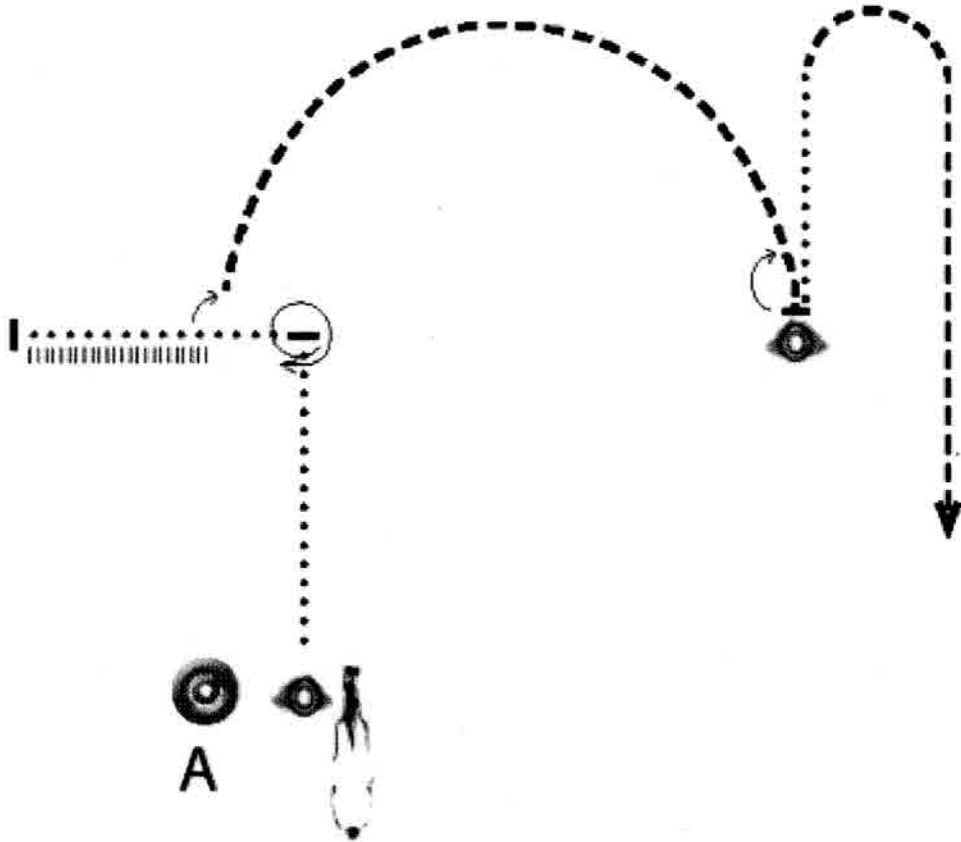

Be ready at A

1. Walk, 270° turn, walk
2. Back up, 90° turn
3. Trot
4. Set up
5. 180° turn, walk,

trot to the warmup area

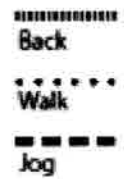



EWU C Turnier Hungen 22.-23.04.2017

Showmanship LK 1

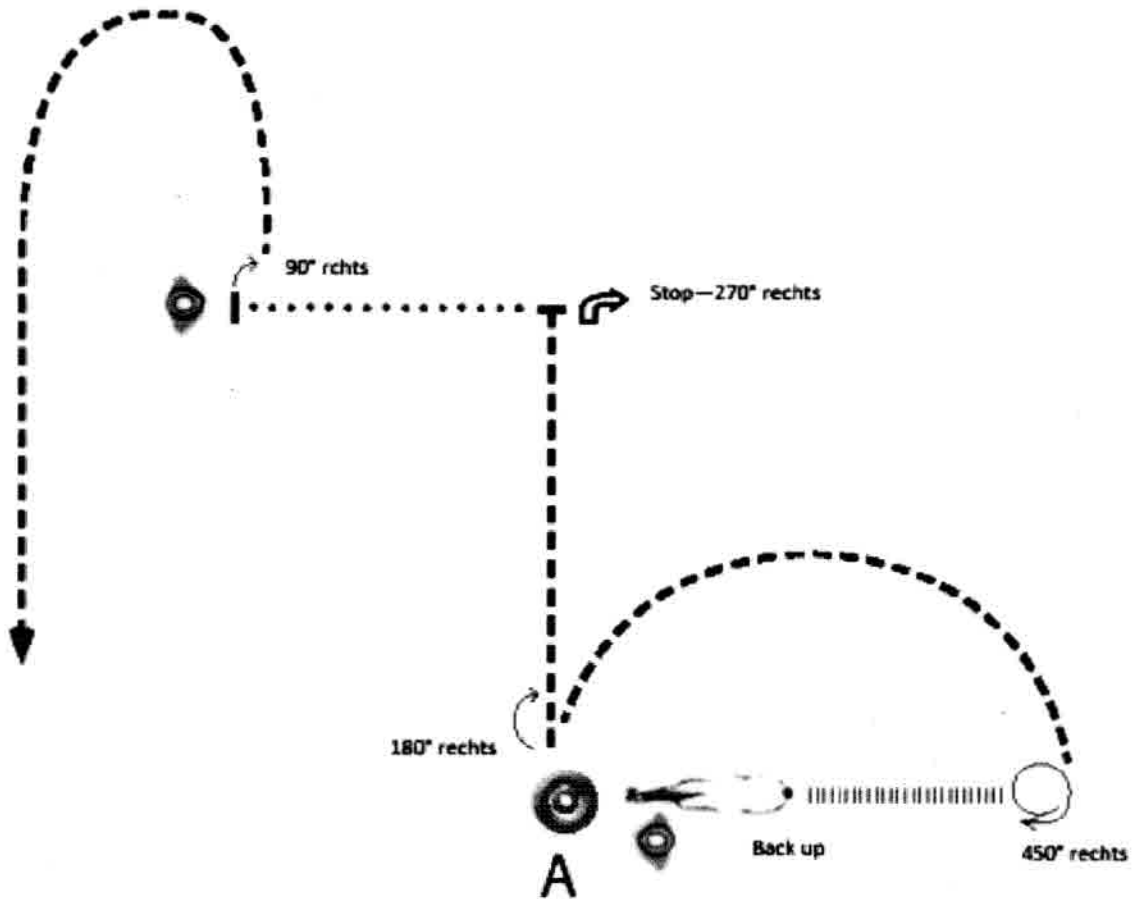

Be ready at A

1. Backup 2 horselength
2. 450° turn
3. Trot to A, 180° turn
4. Trot, stop, 270° turn, walk
5. Set up, 90° turn

trot to the warmup area

Back
Walk
Jog



EWU C Turnier

Hungen

22.-23.04.2017

Trail LK 4/5 B

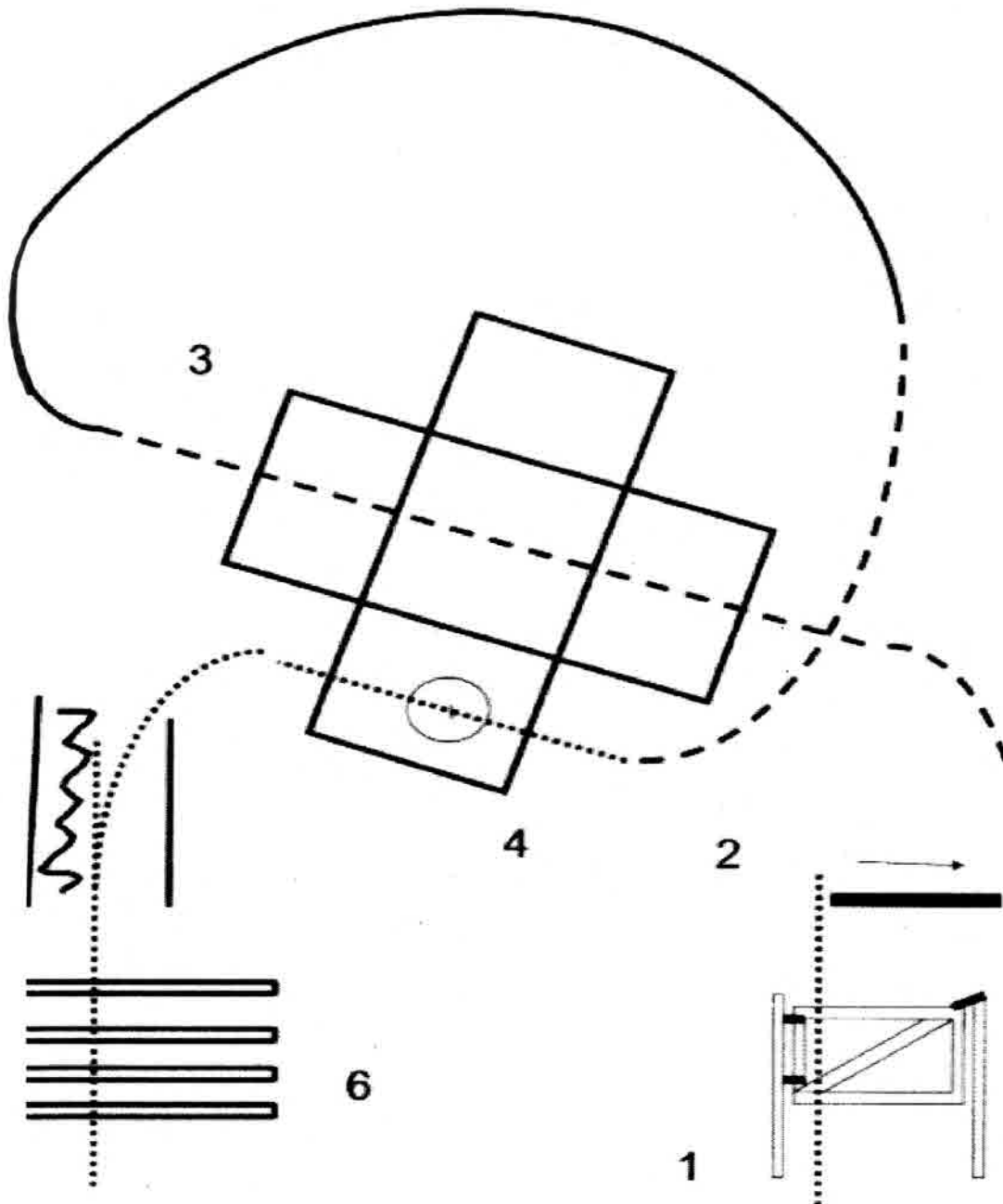

- 1) Tor beliebige Richtung 2) Side Pass rechts 3) Jog, Jog over, 4) Lope, Rechtsgalopp, Jog, 4) Walk, Walk in, 360 Grad beliebige Richtung, Walk out, 5) Walk in, Back up, Walk out, 6) Walk over



EWU C Turnier
Hungen
22.-23.04.2017

Trail LK 4/5 A

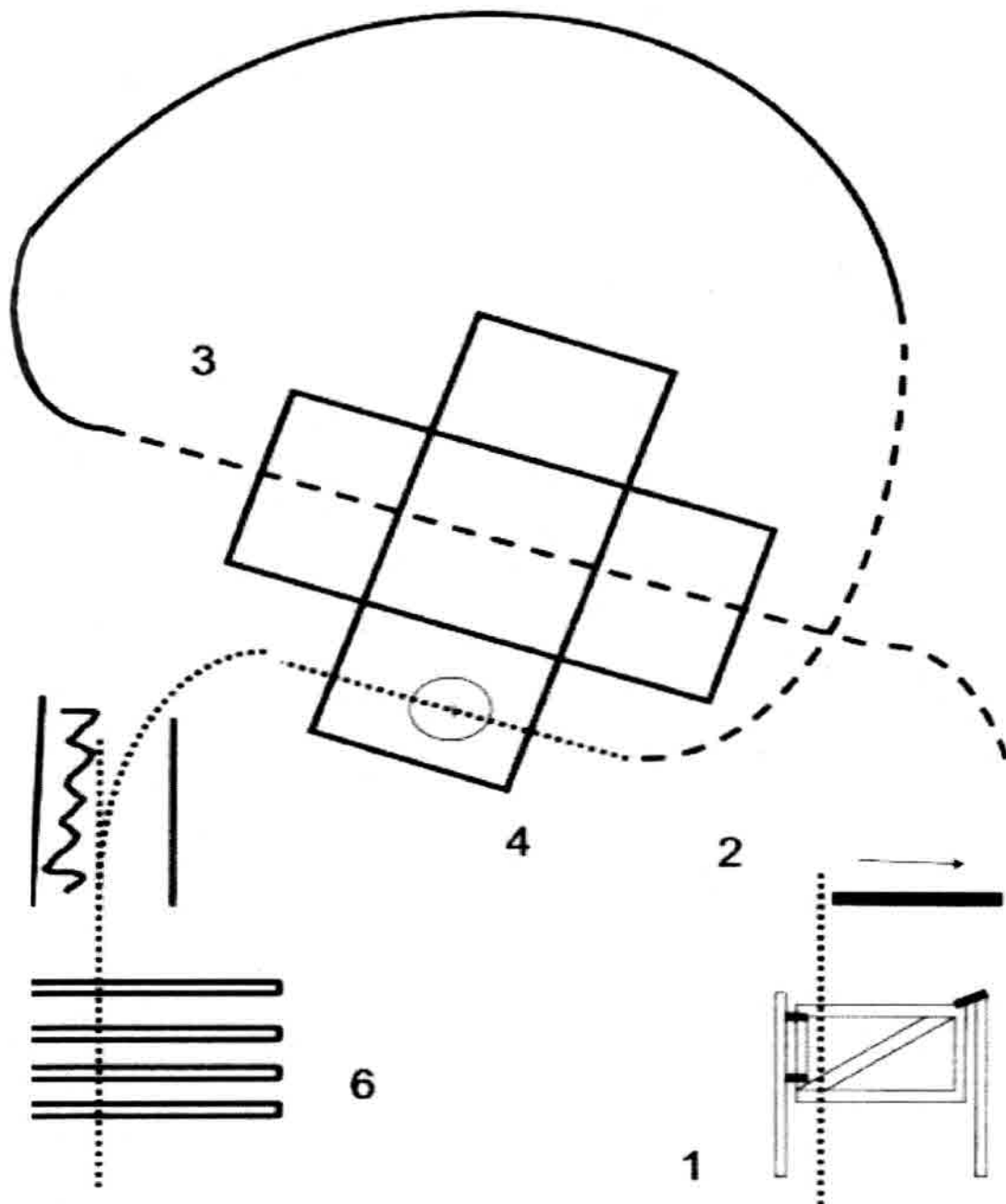

- 1) Tor beliebige Richtung 2) Side Pass rechts 3) Jog, Jog over, 4) Lope, Rechtsgalopp, Jog, 4) Walk, Walk in, 360 Grad beliebige Richtung, Walk out, 5) Walk in, Back up, Walk out, 6) Walk over



EWU C Turnier Hungen 22.-23.04.2017

Trail LK 3 A + 1-3B

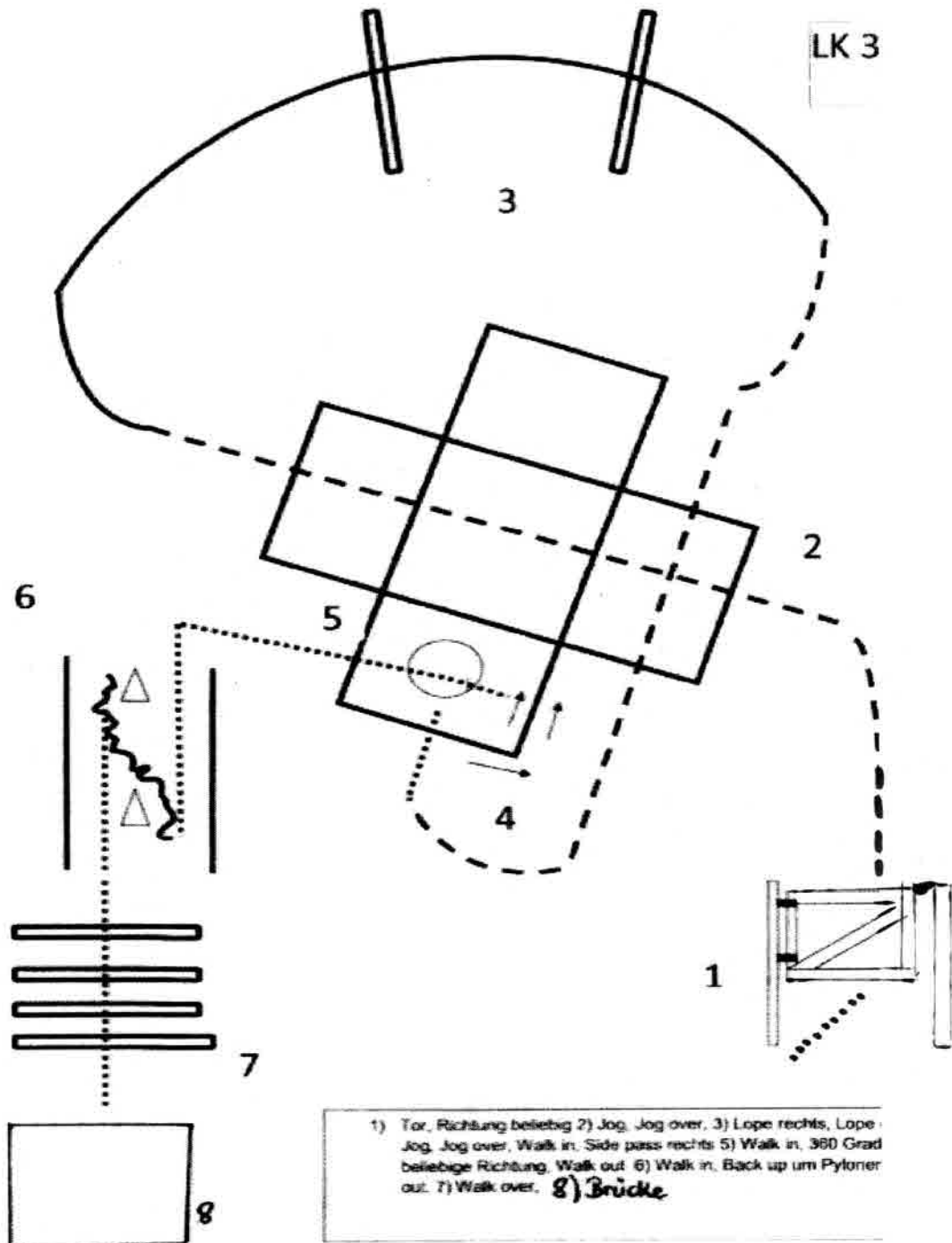



EWU C Turnier
Hungen
22.-23.04.2017

Trail LK 1/2 A

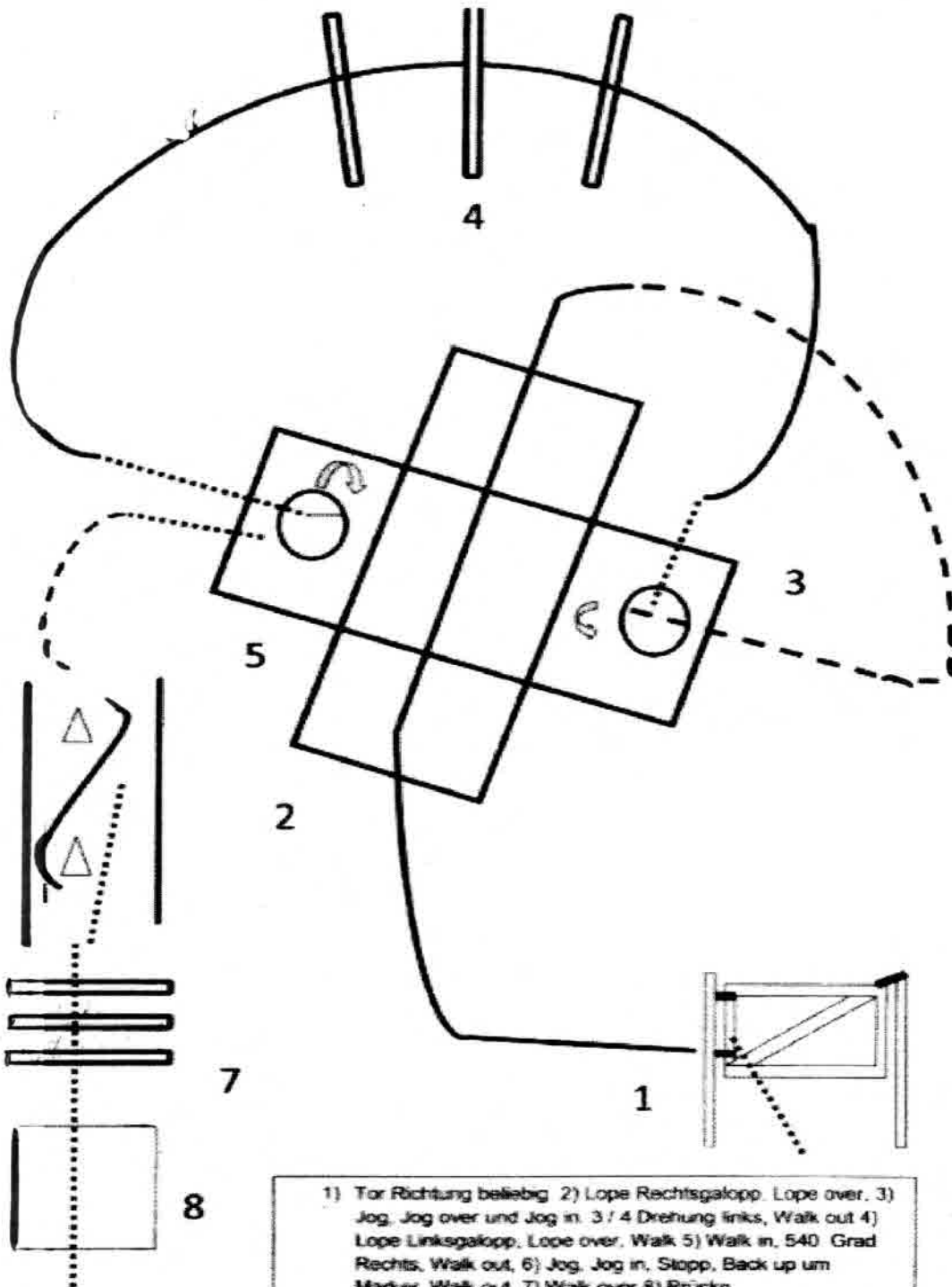

- 1) Tor Richtung beliebig 2) Lope Rechtsgalopp, Lope over, 3) Jog, Jog over und Jog in, 3 / 4 Drehung links, Walk out 4) Lope Linksgalopp, Lope over, Walk 5) Walk in, 540 Grad Rechts, Walk out, 6) Jog, Jog in, Stopp, Back up um Marker, Walk out, 7) Walk over 8) Brücke



EWU C Turnier
Hungen
22.-23.04.2017

Western Horsemanship LK 5

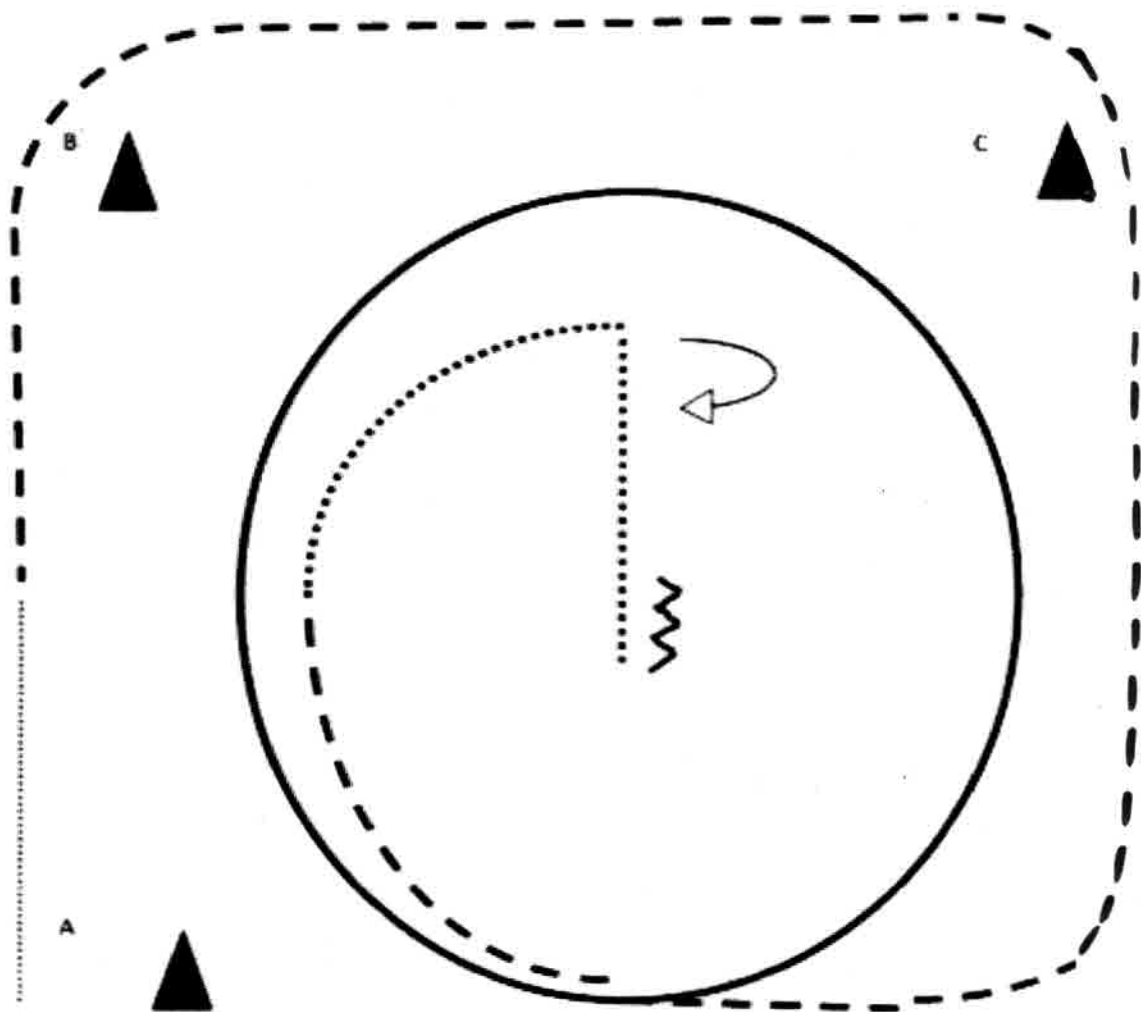

Bei A bereithalten, Walk, Jog, Lope, Jog und Walk Stopp, HHW rechts,
Walk und Back up anhalten, Ende der Aufgabe. Im Walk ausreiten



EWU C Turnier
Hungen
22.-23.04.2017

Western Horsemanship LK 4

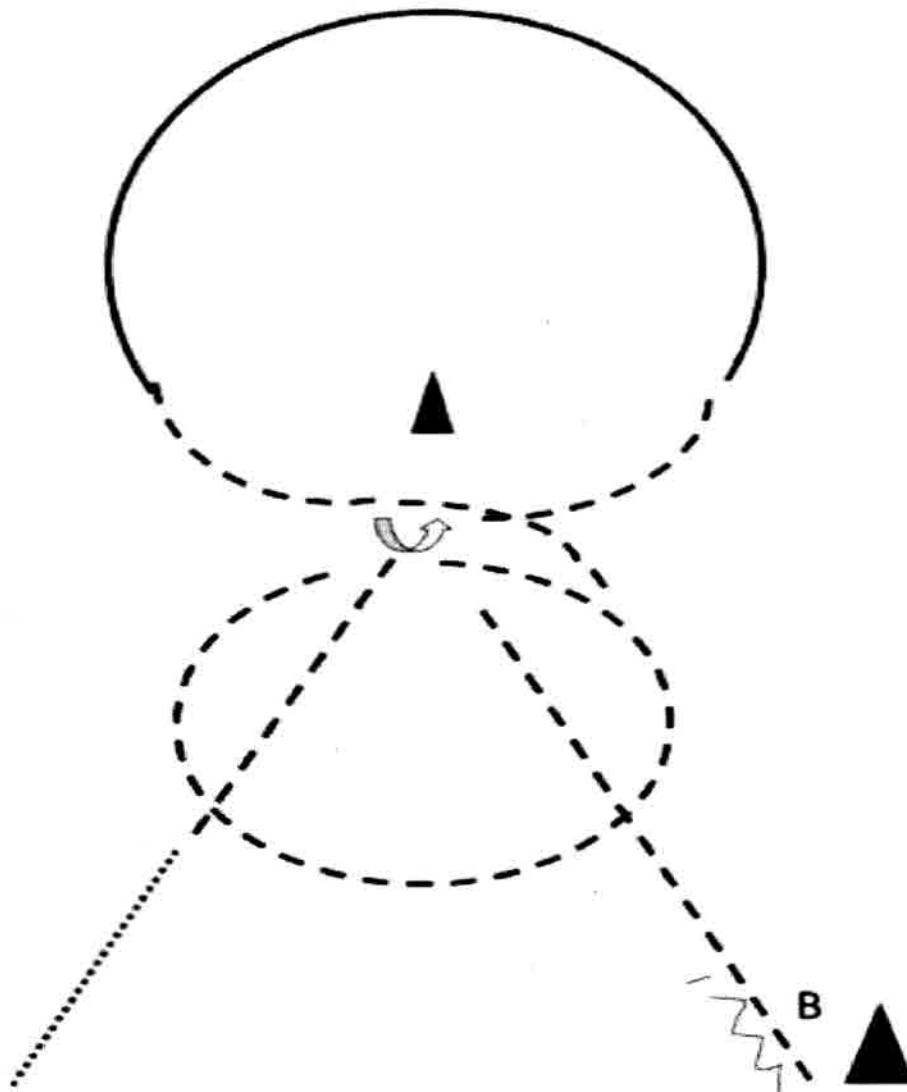

1. An der Pylone A bereit halten, Walk, Jog, Stopp
2. HHW links ca 3 / 4,
3. Jog, Angaloppieren, Lope links Zirkel, Übergang Jog,
4. Jog kleine Rechtsvolte
5. Jog, Anhalten neben Pylone und Back up, Anhalten, Ende der Aufgabe. Im Walk ausreiten.



EWU C Turnier
Hungen
22.-23.04.2017

Western Horsemanship LK 3

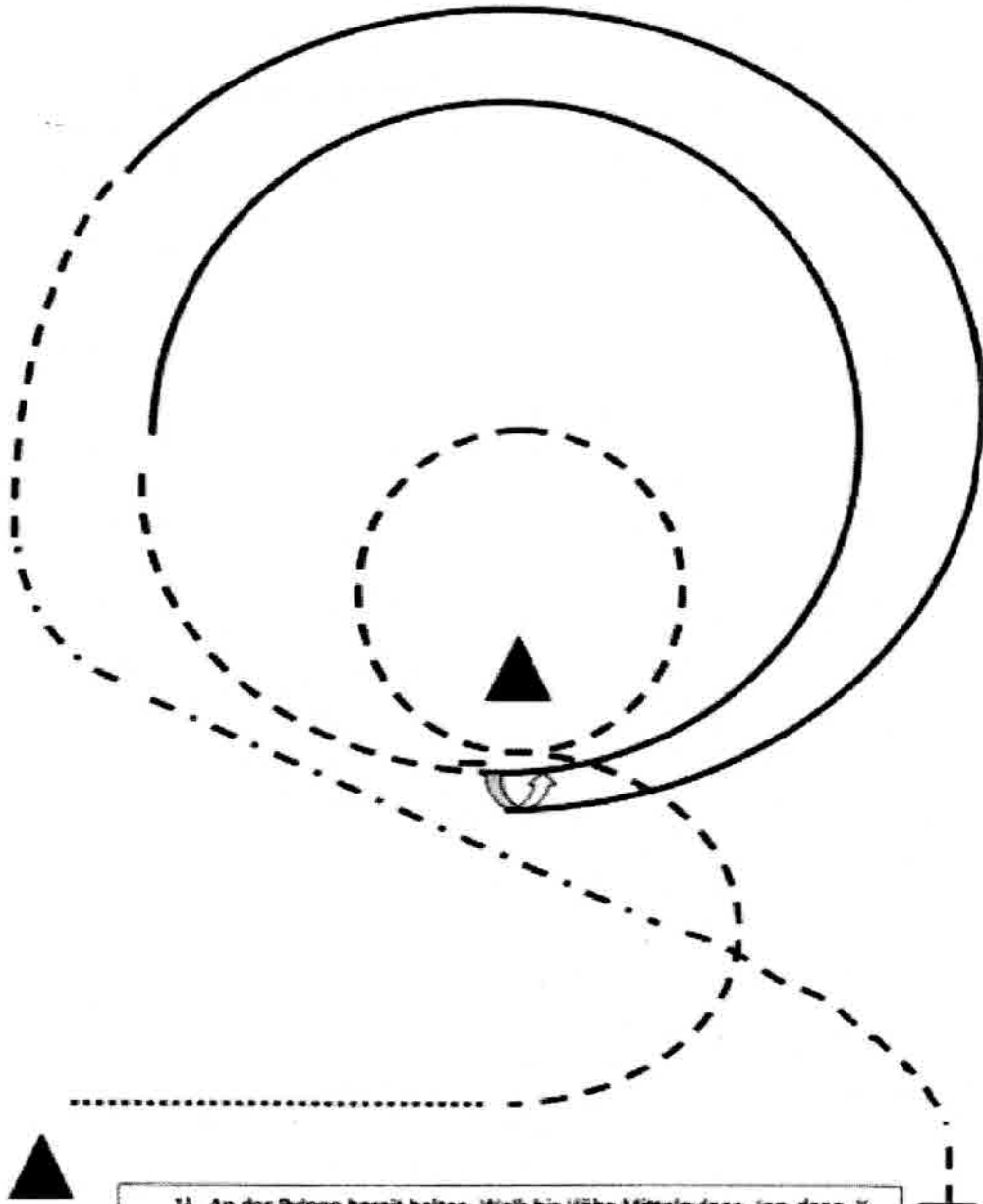

- 1) An der Pylone bereit halten, Walk bis Höhe Mittelpylone, Jog, dann $\frac{1}{4}$ Jogvolte links,
- 2) Jogvolte rechts um Pylone, Jog $\frac{1}{4}$ Zirkel
- 3) Angaloppieren Lope rechts $\frac{3}{4}$ Zirkel, Stopp
- 4) HHW 180 Grad links, Lope links bis $\frac{3}{4}$ Zirkel
- 5) Übergang zum Jog, Extended Jog auf der Geraden, zurück zum Jog, Auf



EWU C Turnier
Hungen
22.-23.04.2017

Western Horsemanship LK 2

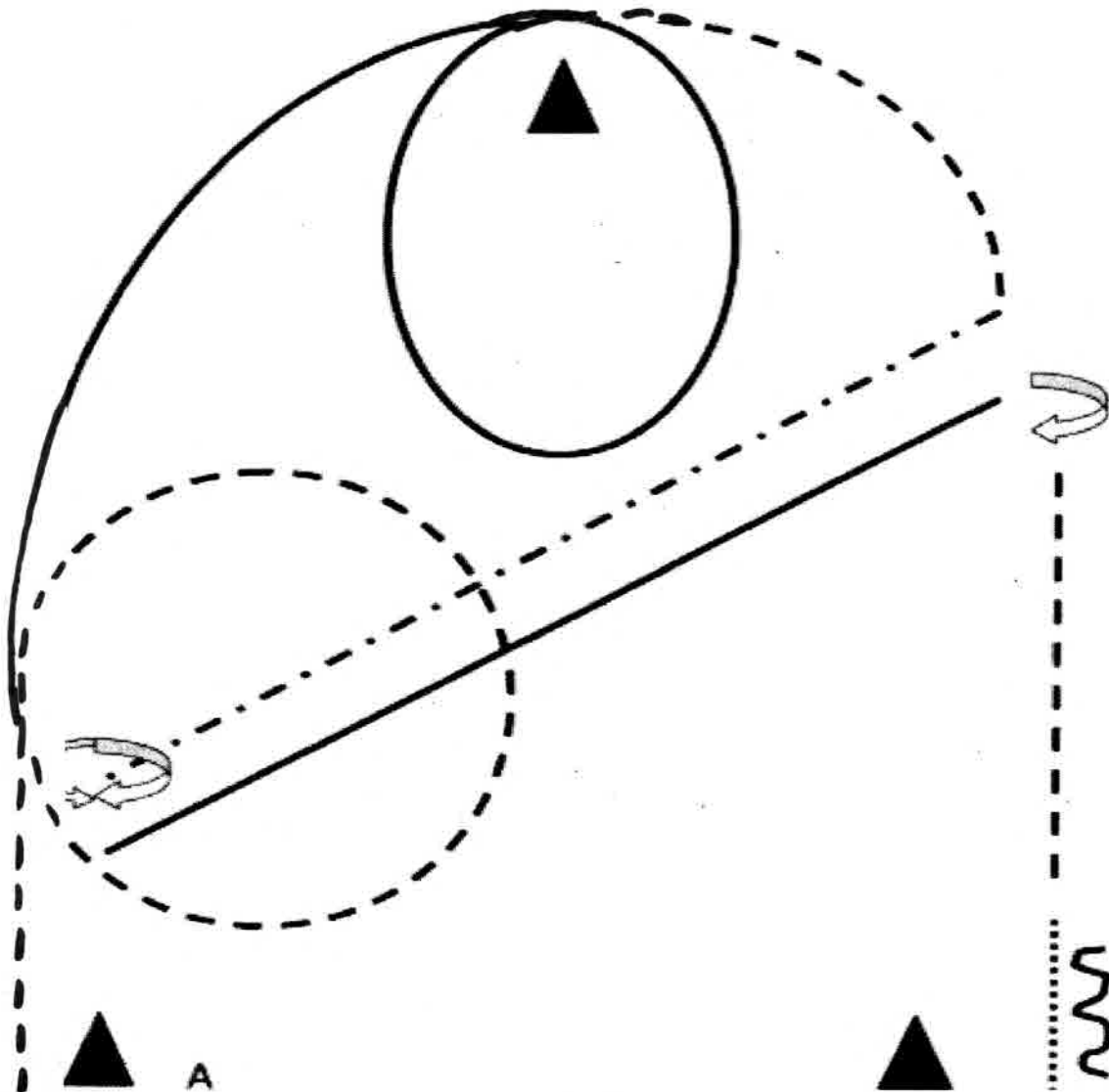

1. Bei A bereit halten. Aus Stand Jog, Jogvolte
2. Lope right lead, Volte rechts.
3. Jog, Extended Jog, Stopp
4. 540 HHW (Richtung wahlweise).
5. Lope left Lead, Stopp, HHW ca 90 Grad rechts
6. Jog, ca 2 /3 des Weges, dann Walk, Anhalten, Back up, Bahn verlassen.



EWU C Turnier Hungen 22.-23.04.2017

Western Horsemanship LK 1

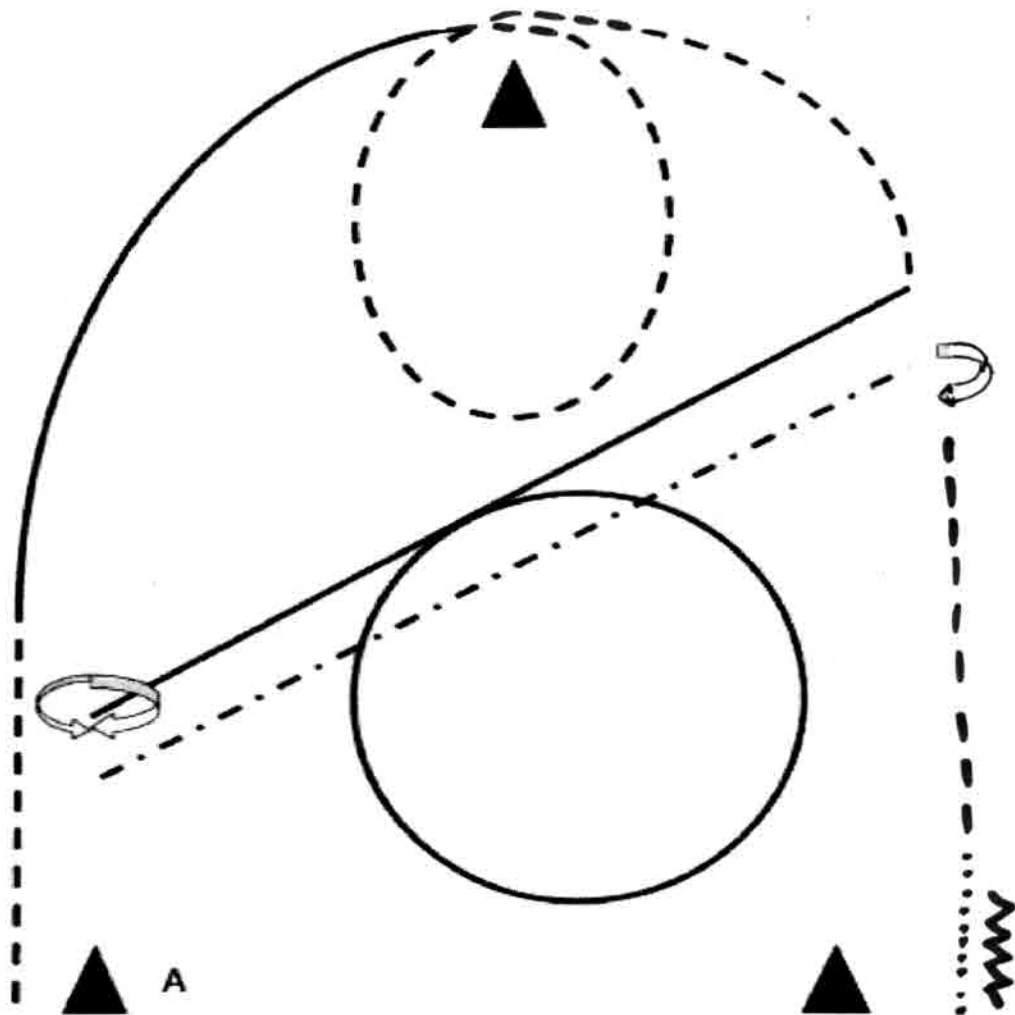

1. Bei A bereit halten. Jog, Lope right lead
2. Durchparieren zu Jog, kleine Jogvolte.
3. Lope left lead, Volte ungefähr auf dem halben Weg des Lopes anlegen.
4. Stop 540 HHW (Richtung wahlweise).
5. Extended Jog, Stop.
6. ca 90 Grad Drehung **rechts** Jog, ca 2/3 des Weges, dann Walk, Anhalten, Back up, Bahn verlassen.



EWU C Turnier

Hungen

22.-23.04.2017

Ranch Trail LK 1-3 A/B

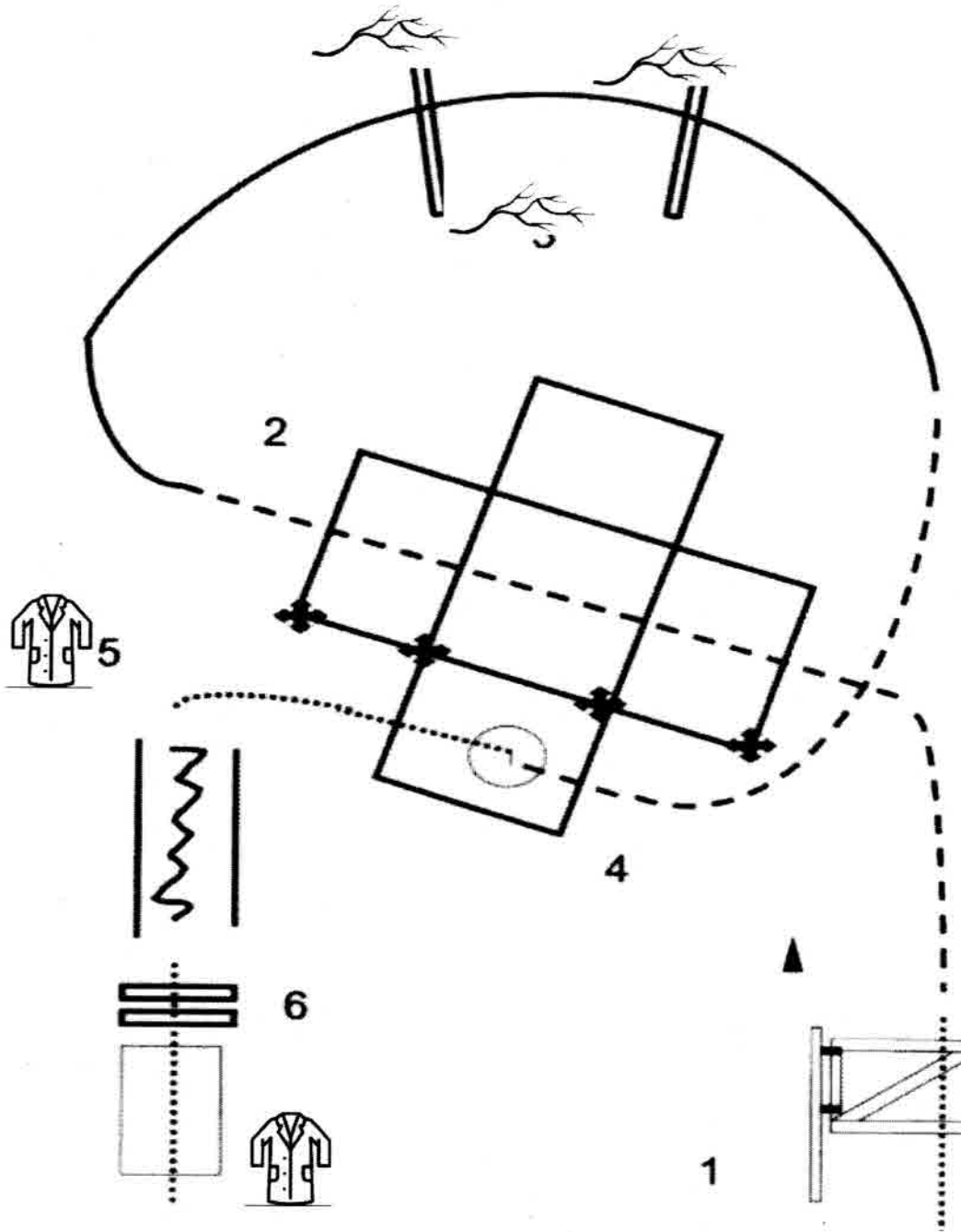



EWU C Turnier

Hungen

22.-23.04.2017

Ranch Trail LK 4/5 A

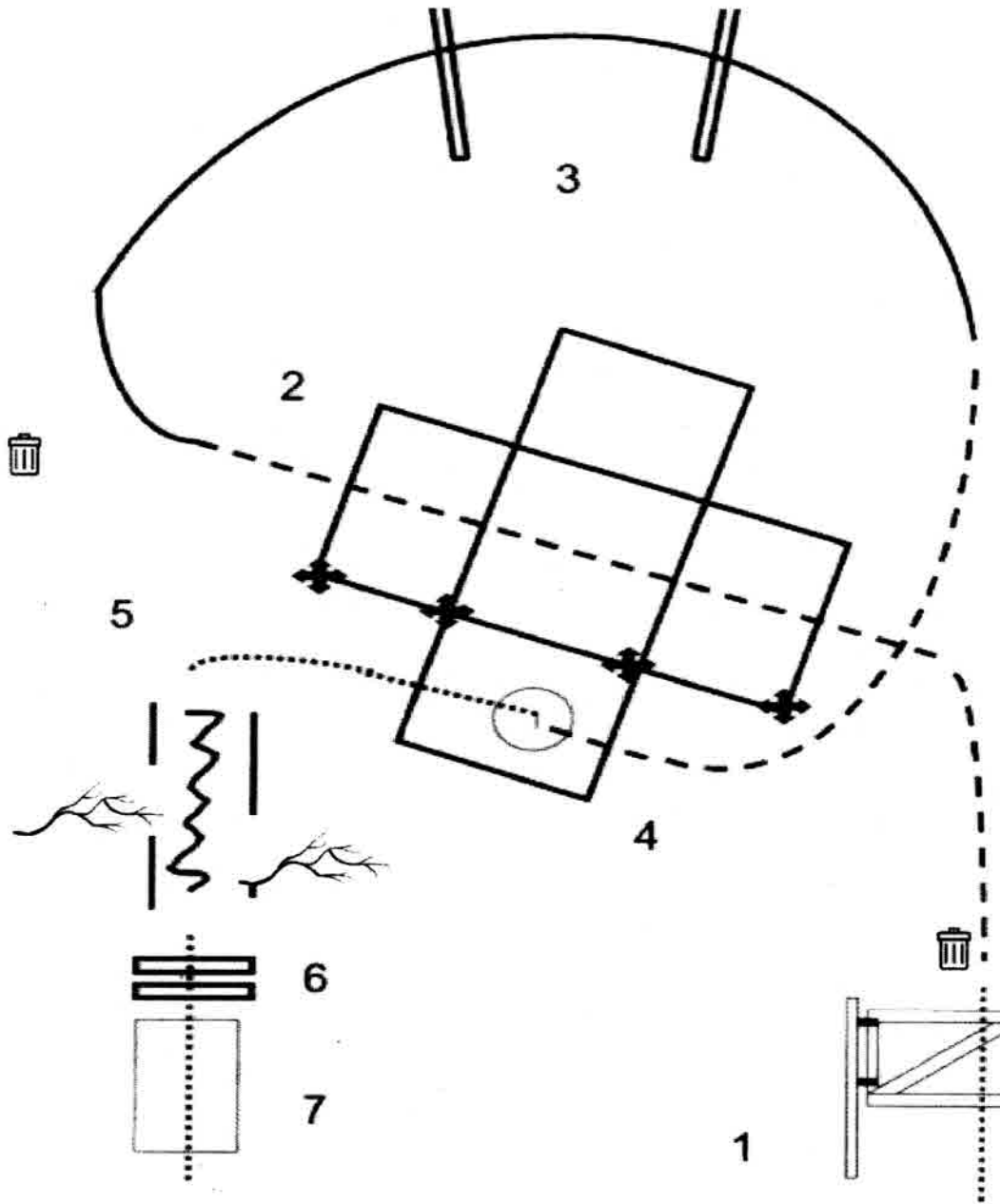



EWU C Turnier

Hungen

22.-23.04.2017

Ranch Riding LK 5 A / B / LK 4 B



2015 Ranch Riding Pattern 16 (Arenagröße mind. 20x40):
LK 4/5 A/B

06/2015

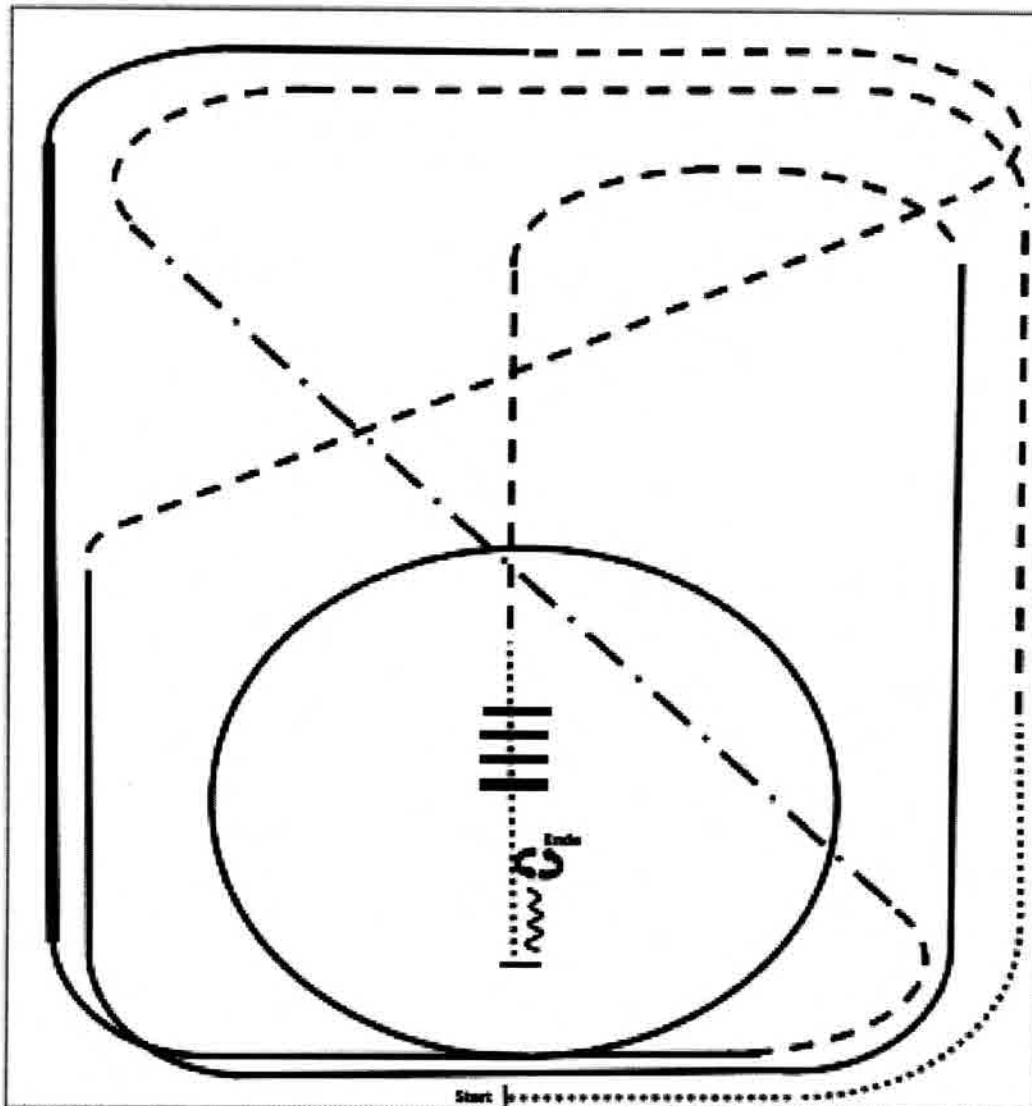

- 1.Walk
- 2.Trot
- 3.Ext.Trot, Trot
- 4.Lope right lead
- 5.Ext. Lope right lead,
Lope right lead
- 6.Trot

- 7.Lope left lead
- 8.Trot
- 9.Walk
- 10.Walk over
- 11.Stop, Back
- 12.Turn left 180°
- 13.Turn right 180°

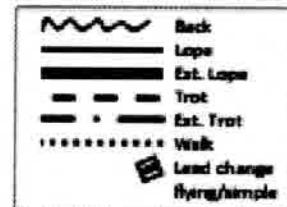



EWU C Turnier

Hungen

22.-23.04.2017

Ranch Riding LK 4 A

EWU 2015 Ranch Riding Pattern 17 (Arenagröße mind. 20x40):
LK 4/5 A/B

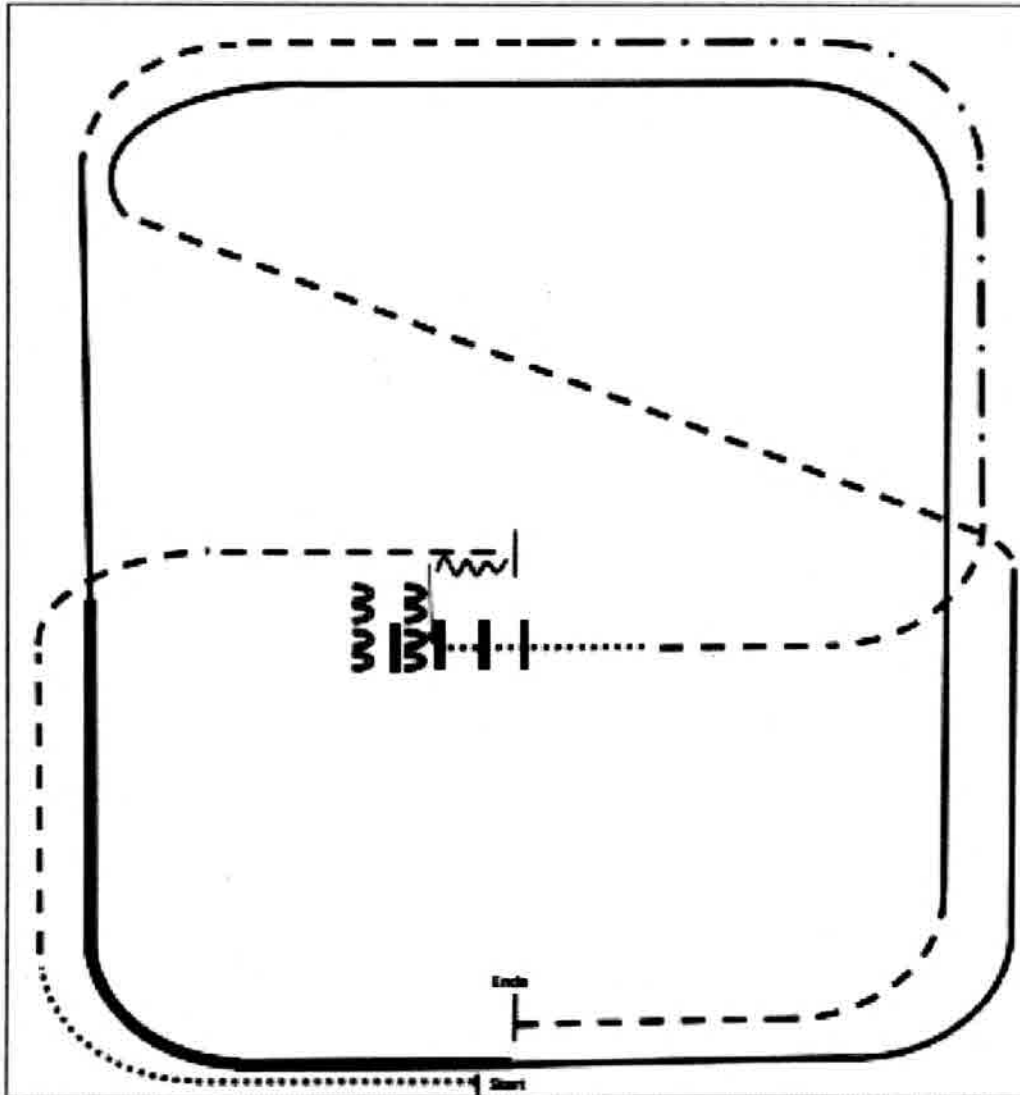

1. Walk
2. Trot
3. Stop, Back
4. Sidepass right 1/2 way
5. Walk over
6. Trot
7. Ext. Trot, Trot

8. Lope left lead
9. Ext. Lope left lead
10. Lope left lead
11. Trot
12. Lope right lead
13. Jog, Stop



Ranch Riding LK 1-3 A/B



EWU C Turnier Hungen 22.-23.04.2017



2015 Ranch Riding Pattern 12 (Arenagröße mind. 20x40): LK 1-3 A/B

06/2011c

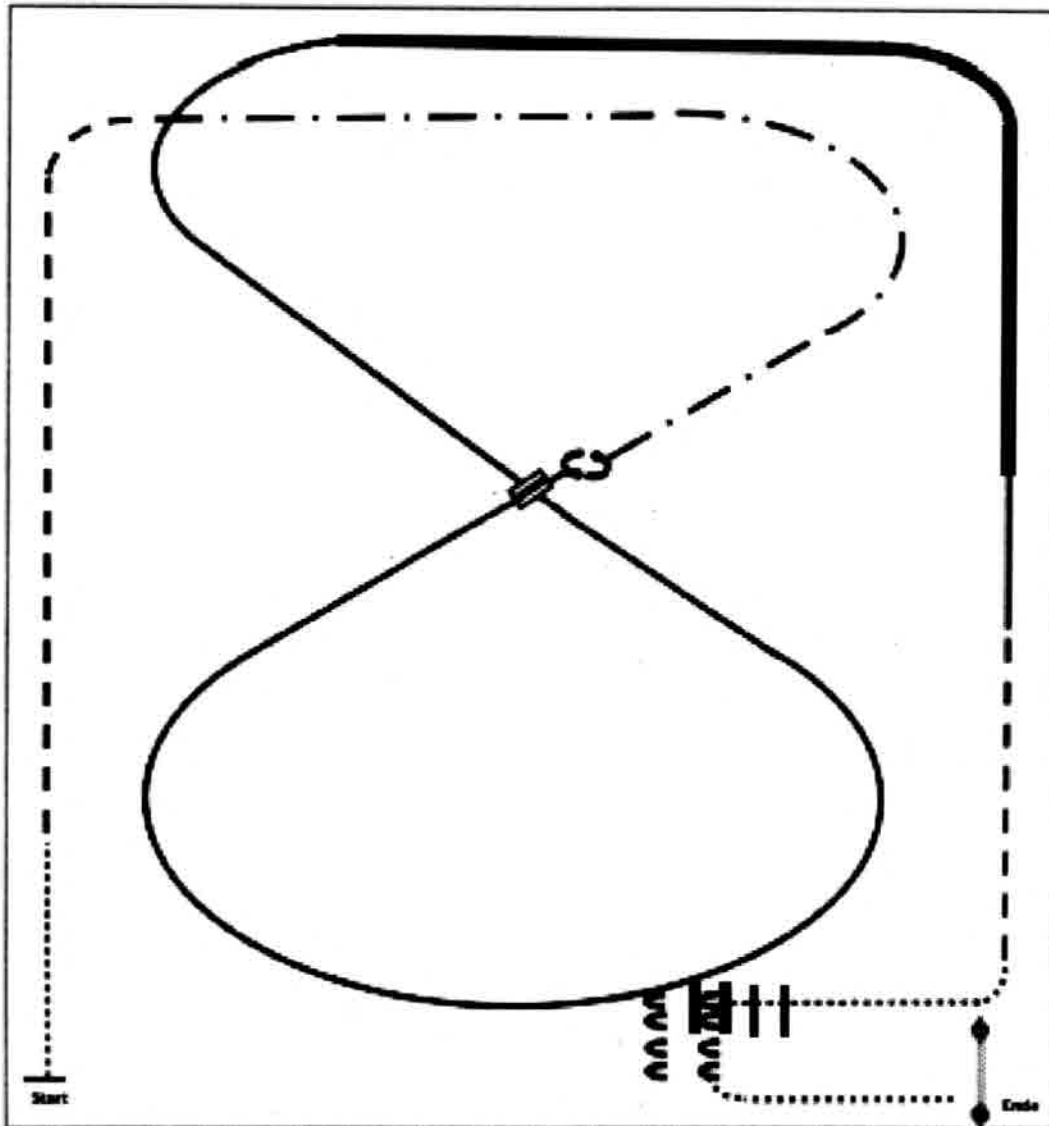

1. Walk
2. Trot
3. Ext. Trot
4. Stop, Turn left 360°
5. Lope left lead
6. Change leads
7. Lope right lead

8. Ext. Lope right lead, Lope right lead
9. Trot
10. Walk
11. Walk over
12. Sidepass left, Turn left 180°
13. Gate right hand push

	Beck
	Lope
	Ext. Lope
	Trot
	Ext. Trot
	Walk
	Lead change flying/sample



EWU C Turnier

Hungen

22.-23.04.2017

Walk Trot Trail

Walk Trot Trail (Nr.1)

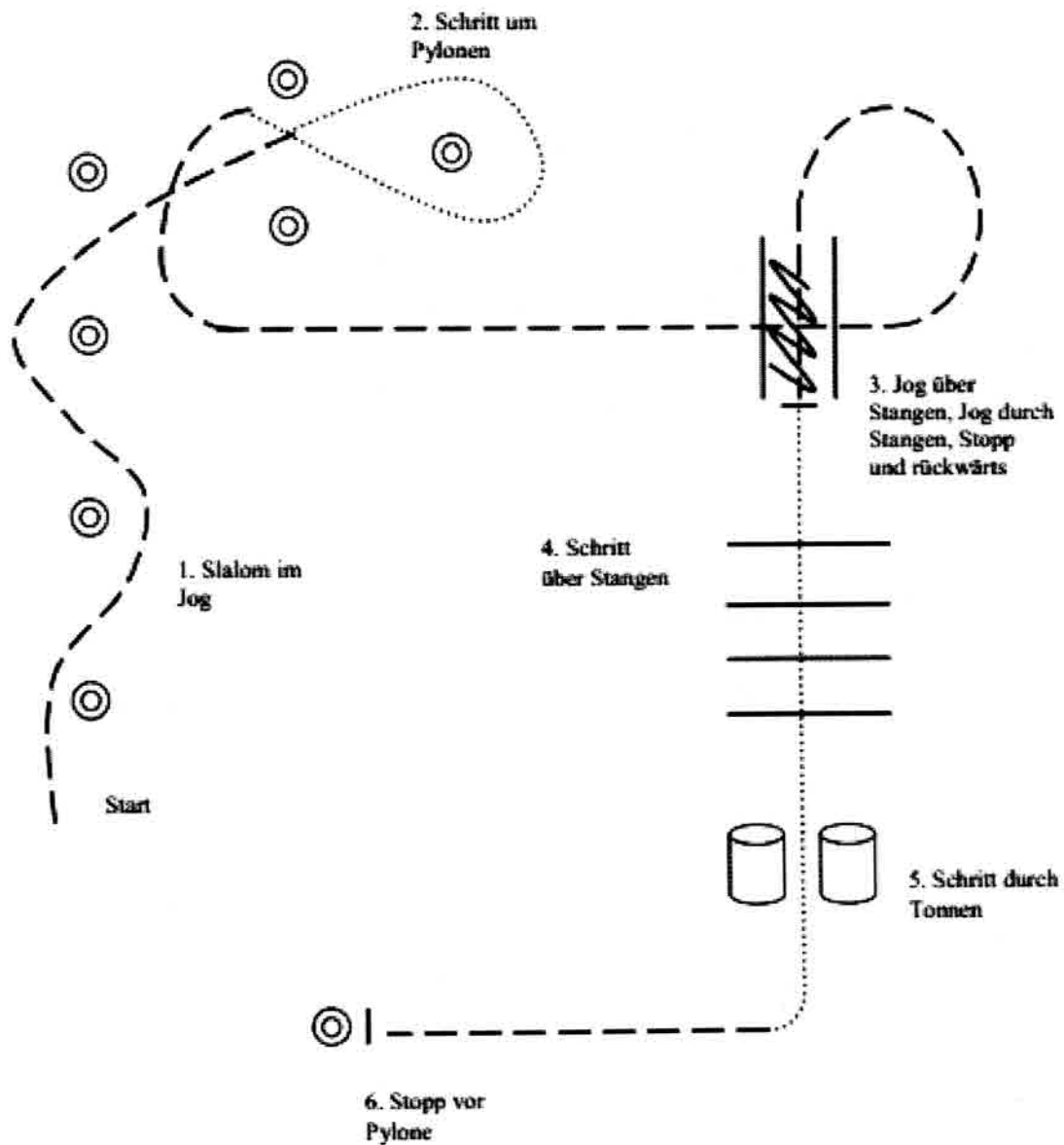



EWU C Turnier
Hungen
22.-23.04.2017

Walk Trot Western Horsemanship

Walk Trot Western Horsemanship (Nr.2)

Von A nach B Jog
Bei B Jogvolte links
Von B bis C Jog
Von C bis D Schritt
Bei D Schrittvolte links
Schritt bis E, Stopp und mind. 3 m
rückwärts
½ Hinterhandwendung links
Schritt bis B, Stopp

Im Schritt zurück zum Line Up

