

MEGA EVENT | 36 TITEL - 180 STARTER



27.07.2023 - 30.07.2023

# Landesmeisterschaft

## BADEN-WÜRTTEMBERG

13.000 € PREISGELD | HIGH PRICE DISZIPLIN TRAIL

## Turnierleitung

Thomas Tuscher  
0162/4405091

## Meldestelle

Nicole Siegwart  
Lisa Tuscher  
0151/18438477

## Richter

Bettina Egenter  
Victoria Stock

## Ringsteward

Anna-Alisa Samse  
Pia Zenner

## Steward

Christa Sautter  
0173/4470275  
Ulrike Lorch-Taulke  
0173/3012571

## Turnierteam

Thomas Tuscher  
Stefanie Kuhn  
Kerstin Rutsch  
Kai Gicklhorn  
Desiree Gröger-Dick  
Miriam Alva  
Tamara Kiefer  
Vanessa Beck

## Hufschmied

Timo Bürkle  
0162/9195110

## Tierarzt

Alessa Hofer  
01517 /4207627

## Fotografen

LUX Company

## Sprecher / Ersthelfer:

Patrick Brueggen

## Parcours-Team

Andy Haas & Team

## Siegerehrung

Miriam Alva  
Tamara Kiefer

## Sponsoring & Sachpreise

Stefanie Kuhn  
Vanessa Beck



### Welcome Party

27. Juli - ab 20 Uhr

Wir freuen uns, euch auch in diesem Jahr wieder zu unserer beliebten Welcome Party begrüßen zu dürfen! Wir laden euch ein: Am Donnerstag den 27. Juli ab 20 Uhr im Biergarten des Küffner-Hofs - für das leibliche Wohl ist gesorgt!

### Sponsorenempfang

29. Juli - 20 Uhr

Willkommen zum Sponsorenempfang! Am Samstag den 29. Juli begrüßen wir unsere Sponsoren im Biergarten des Küffner Hofs zu einem leckeren Abendessen.

**Lavisano**<sup>®</sup>  
PFERDEFUTTER



# ZEITPLAN



## Endgültiger Zeitplan

### Öffnungszeiten der Meldestelle

27.07.2023: 07:30 - 16:00  
27.07.2023: 16:30 - 22:00

28.07.2023: 06:00 - 13:00  
28.07.2023: 13:30 - 22:00

29.07.2023: 06:00 - 13:00  
29.07.2023: 13:30 - 22:00

30.07.2023: 06:00 - 13:00  
30.07.2023: 13:30 - 18:00

### Abreitezeiten

27.07.2023: 06:00 - 09:00  
27.07.2023: 21:00 - 22:00

28.07.2023: 06:00 - 07:00  
28.07.2023: 22:00 - 23:55

29.07.2023: 06:00 - 07:00  
29.07.2023: 21:00 - 22:00

30.07.2023: 06:00 - 07:00

### 27.07.2023 Halle

09:00 - 09:40	LK 1A sen Trail	Nennungen: 14
09:40 - 10:15	LK 2A sen Trail	Nennungen: 12
10:15 - 10:45	LK 1-3B Trail	Nennungen: 9
10:45 - 11:15	LK 1 jun Trail	Nennungen: 11
11:15 - 11:35	LK 2 jun Trail	Nennungen: 5
11:35 - 12:25	LK 3A Trail	Nennungen: 19
12:25 - 12:40	LK 1A sen. Western Pleasure	Nennungen: 5
12:40 - 12:55	LK 2A sen. Western Pleasure	Nennungen: 8
12:55 - 13:10	LK 1-3B Western Pleasure	Nennungen: 10
13:10 - 13:25	LK 1 jun Western Pleasure	Nennungen: 7
13:25 - 13:40	LK 2 jun. Western Pleasure	Nennungen: 7
13:40 - 14:10	LK 3A Western Pleasure	Nennungen: 17
14:10 - 14:30	LK 1A sen Western Riding	Nennungen: 6
14:30 - 14:50	LK 2A sen Western Riding	Nennungen: 5
14:50 - 15:05	LK 1 jun Western Riding	Nennungen: 3
15:05 - 15:15	LK 2 jun Western Riding	Nennungen: 2
15:15 - 15:35	LK 3A Western Riding	Nennungen: 4
15:35 - 16:00	LK 3B Western Riding	Nennungen: 3
16:00 - 16:20	Pause	
16:20 - 17:20	LK 1/2A sen Superhorse	Nennungen: 12
17:20 - 18:15	Jungpferde Ranch Riding 4jährig	Nennungen: 14
18:15 - 19:05	Jungpferde Ranch Riding 5jährig	Nennungen: 12
19:05 - 19:20	LK 1A sen Western Ranch Rail	Nennungen: 9
19:20 - 19:40	LK 2A sen Western Ranch Rail	Nennungen: 12
19:40 - 20:10	LK 3A Western Ranch Rail	Nennungen: 16
20:10 - 20:25	LK 1-3B Western Ranch Rail	Nennungen: 10
20:25 - 20:40	LK 1 jun Western Ranch Rail	Nennungen: 5
20:40 - 20:50	LK 2 jun Western Ranch Rail	Nennungen: 5

# ZEITPLAN



## Endgültiger Zeitplan

### 27.07.2023 Halle

### 28.07.2023 Halle

07:00 - 07:50	LK 3A Ranch Riding	Nennungen: 21
07:50 - 08:05	LK 1 jun Ranch Riding	Nennungen: 4
08:05 - 08:20	LK 2 jun Ranch Riding	Nennungen: 4
08:20 - 09:10	LK 1A sen Ranch Riding	Nennungen: 18
09:10 - 09:50	LK 2A sen Ranch Riding	Nennungen: 15
09:50 - 10:25	LK 1-3B Ranch Riding	Nennungen: 12
10:25 - 11:45	Jungpferde Basis 4jährig	Nennungen: 17
11:45 - 13:20	Jungpferde Basis 5jährig	Nennungen: 21
13:20 - 13:50	LK 1A Western Horsemanship	Nennungen: 12
13:50 - 14:20	Pause	
14:20 - 14:50	LK 2A Western Horsemanship	Nennungen: 11
14:50 - 15:20	LK 1-3B Western Horsemanship	Nennungen: 12
15:20 - 16:10	LK 3A Western Horsemanship	Nennungen: 24
16:10 - 16:55	Youngstars Challenge 6jährig	Nennungen: 11
16:55 - 17:10	Youngstars Challenge 7jährig	Nennungen: 3
17:10 - 17:45	LK 3A Reining	Nennungen: 7
17:45 - 18:05	LK 1-3B Reining	Nennungen: 4
18:05 - 19:05	LK 1A sen Reining	Nennungen: 12
19:05 - 19:40	LK 2A sen Reining	Nennungen: 7
19:40 - 20:30	LK 1/2 jun Reining	Nennungen: 9
20:30 - 20:55	M LK 2/1B sen Superhorse	Nennungen: 4
20:55 - 21:45	M LK 2/1A sen Superhorse	Nennungen: 13

### 29.07.2023 Halle

07:00 - 07:30	LK 3A Showmanship at Halter	Nennungen: 9
07:30 - 07:55	LK 1-3B Showmanship at Halter	Nennungen: 8
07:55 - 08:25	LK 1/2A Showmanship at Halter	Nennungen: 9
08:25 - 09:15	M LK 2/1A Showmanship at Halter	Nennungen: 11
09:15 - 09:40	M LK 2/1B Showmanship at Halter	Nennungen: 4
09:40 - 10:05	Youngstars Reining 6jährig	Nennungen: 6
10:05 - 10:50	Youngstars Reining 7jährig	Nennungen: 4
10:50 - 11:10	M LK 2/1B Reining	Nennungen: 4
11:10 - 12:20	Jungpferde Trail 4jährig	Nennungen: 11
12:20 - 13:45	Jungpferde Trail 5jährig	Nennungen: 15
13:45 - 14:15	Pause	



## Endgültiger Zeitplan

29.07.2023		Halle	
14:15	- 15:05	M LK 2/1A sen Western Riding	Nennungen: 15
15:05	- 15:40	M LK 2/1B Western Riding	Nennungen: 5
15:40	- 16:15	M LK 2/1 jun Western Riding	Nennungen: 6
16:15	- 16:40	M LK 2/1B Western Pleasure	Nennungen: 4
16:40	- 17:15	M LK 2/1A sen Western Pleasure	Nennungen: 14
17:15	- 17:55	M LK 2/1 jun. Western Pleasure	Nennungen: 16
17:55	- 19:20	M LK 2/1A sen Reining	Nennungen: 14
19:20	- 20:35	M LK 2/1 jun Reining	Nennungen: 12
30.07.2023		Halle	
07:00	- 07:45	M LK 2/1B Michaela Wieland -Bemerpartner Trail	Nennungen: 8
07:45	- 08:50	M LK 2/1 Style Up Leather & Silver jun Trail	Nennungen: 15
08:50	- 10:25	M LK 2/1A Lavisano sen Trail	Nennungen: 28
10:25	- 11:05	M LK 2/1 jun Western Ranch Rail	Nennungen: 14
11:05	- 11:25	M LK 2/1B Western Ranch Rail	Nennungen: 4
11:25	- 12:25	M LK 2/1A sen Western Ranch Rail	Nennungen: 26
12:25	- 12:55	Pause	
12:55	- 13:50	Jungpferde Reining 4jährig	Nennungen: 8
13:50	- 14:45	Jungpferde Reining 5jährig	Nennungen: 8
14:45	- 15:25	M LK 2/1B Western Horsemanship	Nennungen: 7
15:25	- 16:30	M LK 2/1A Western Horsemanship	Nennungen: 19
anschl.		M LK 2/1B Ranch Riding	Nennungen: 6
anschl.		M LK 2/1A sen Ranch Riding	Nennungen: 24
anschl.		M LK 2/1 jun Ranch Riding	Nennungen: 15



**BE MER**  
PARTNER  
Michaela Wieland

# TEILNEHMER

## EWU Turnier: Landesmeisterschaft EWU Baden-Württemberg

Start Nr.	Reiter	LK	LV	Pferd	Rasse
1	Claudia Steinhilber	LK 1A	BAWÜ	Little Travalin Nic	QH
	LK 1A sen RR ,LK 1A sen TH ,LK 1A sen WR ,LK 1A sen WRR ,LK 1A WHS ,M LK 2/1 A sen TH ,M LK 2/1 A WHS				
2	Elena Schorpp	LK 1A	BAWÜ	Copperscotch Percy	QH
	JUPF BA 4j ,JUPF TH 4j ,LK 1/2 A SSH ,M LK 2/1 A SSH ,M LK 2/1 jun TH ,M LK 2/1 jun WPL				
3	Elena Stark	LK 3B	BAWÜ	My Fame Gin	PHM
	LK 1-3 B TH ,LK 1-3 B WHS ,LK 1-3 B WPL ,LK 1-3B WRR				
4	Jana Stark	LK 3B	BAWÜ	My Fame Gin	PHM
	LK 1-3B RR				
5	Svenja Wagner	LK 3A	BAWÜ	No Scotchin Chips	QH
	LK 3A RR ,LK 3A TH ,LK 3A WHS ,LK 3A WPL ,LK 3A WR				
6	Jessica Kull	LK 2A	BAWÜ	Docs Cats Peponita	PH
	LK 2A sen RR ,LK 2A sen WRR ,M LK 2/1 A sen RR ,M LK 2/1A sen WRR				
7	Pia Maier	LK 3A	BAWÜ	Sheerin The Queen	QH
	LK 3A SSH ,LK 3A TH ,LK 3A WPL				
8	Nadja Götz	LK 1A	BAWÜ	BE Peppys Blue Hanc	QH
	JUPF BA 5j ,JUPF RR 5j ,JUPF TH 5j ,LK 1 jun RR ,LK 1 jun WPL ,LK 1 jun WRR ,M LK 2/1 jun RR ,M LK 2/1 jun WPL ,M LK 2/1 jun WRR				
9	Sonja Bögl	LK 1A	BAWÜ	Elta Golden Love	QH
	JUPF BA 5j ,JUPF RN 5j ,JUPF RR 5j ,LK 1 jun RR ,LK 1 jun WRR ,LK 1/2 jun RN ,M LK 2/1 jun RN ,M LK 2/1 jun RR ,M LK 2/1 jun WRR				
10	Anne Sarbacher	LK 1A	BAWÜ, RLP	FR Bay And Naughty	QH
	LK 1/2 A sen SUHO ,LK 1A sen RR ,LK 1A sen TH ,LK 1A sen WRR ,M LK 2/1 A sen RR ,M LK 2/1 A sen SUHO ,M LK 2/1 A sen TH ,M LK 2/1A sen WRR				
11	Maggie Ellsäßer	LK 2A	BAWÜ	Chex Little Rose	QH
	LK 2A sen RR ,LK 2A sen WRR ,M LK 2/1 A sen RR ,M LK 2/1A sen WRR				
12	Leonie Kugler	LK 2A	BAWÜ	Butter Bisquit	QH
	LK 2 jun RR ,LK 2 jun TH ,LK 2 jun WR ,LK 2 jun WRR ,M LK 2/1 jun RN ,M LK 2/1 jun RR ,M LK 2/1 jun TH ,M LK 2/1 jun WR ,M LK 2/1 jun WRR ,YS CH 6j ,YS RN 6j				
13	Caroline Mak	LK 2B	BAWÜ	Mister Happy Spock	PH
	LK 1-3 B TH ,LK 1-3 B WHS ,LK 1-3 B WPL ,LK 1-3B RR ,LK 1-3B WRR ,M LK 2/1 B RN ,M LK 2/1 B RR ,M LK 2/1 B sen SUHO ,M LK 2/1 B SSH ,M LK 2/1 B TH ,M LK 2/1 B WHS ,M LK 2/1B WR ,M LK 2/1B WRR				
14	Lina Sophie Bauer	LK 2A	BAWÜ	VH Smart N Shining	QH
	JUPF BA 5j ,JUPF RN 5j ,JUPF RR 5j ,M LK 2/1 jun RN ,M LK 2/1 jun RR				
15	Celina Schneider	LK 1A	BAWÜ	Savvy Spiderlady	QH
	LK 1A sen TH ,LK 1A sen WPL ,M LK 2/1 A sen TH ,M LK 2/1 A sen WPL ,M LK 2/1 A SSH				
16	Celina Schneider	LK 1A	BAWÜ	Awesome on Ice	QH
	LK 1A sen TH ,LK 1A sen WR ,M LK 2/1 A sen TH ,M LK 2/1A sen WR				
17	Melanie Huber	LK 3B	BAWÜ	Pike Pachee	QH
	LK 1-3 B RN ,LK 1-3 B SSH ,LK 1-3 B TH ,LK 1-3 B WHS ,LK 1-3 B WPL ,LK 1-3B RR ,LK 1-3B WRR ,LK 3B WR				
18	Sophia Rau	LK 3A	BAWÜ	Call Me Miss Diesel	QH
	JUPF BA 5j ,JUPF TH 5j				
19	Cid Joel Franzini	LK 1B	BAWÜ	Blazing Attachment	QH
	M LK 2/1 B RR ,M LK 2/1 B sen SUHO ,M LK 2/1 B TH ,M LK 2/1 B WHS ,M LK 2/1 B WPL ,M LK 2/1B WR				
20	Cid Joel Franzini	LK 1B	BAWÜ	The One That I Want	QH
	M LK 2/1 B RR ,M LK 2/1 B sen SUHO ,M LK 2/1 B SSH ,M LK 2/1 B TH ,M LK 2/1B WR				
21	Stefanie Kuhn	LK 1A	BAWÜ	Sheerin The Queen	QH
	JUPF BA 5j ,JUPF TH 5j ,M LK 2/1 jun TH				

# TEILNEHMER

## EWU Turnier: Landesmeisterschaft EWU Baden-Württemberg

22	Gesa Meier-Bidmon	LK 2A	BAWÜ	Its a Blue Honor	QH
	LK 2A sen TH ,LK 2A sen WPL ,LK 2A sen WR ,M LK 2/1 A sen TH ,M LK 2/1 A sen WPL ,M LK 2/1A sen WR				
23	Tanja Stöhr	LK 2A	BAWÜ	My Summertime Blues	QH
	JUPF BA 5j ,JUPF TH 5j ,LK 1/2 A SSH ,LK 2 jun WPL ,M LK 2/1 A SSH				
24	Hannes Bolz	LK 1A	BAWÜ	Smoken Easter Money	QH
	LK 1A sen RN ,M LK 2/1 A sen RN				
25	Hannes Bolz	LK 1A	BAWÜ	Topsplayingbadger	QH
	JUPF BA 5j ,JUPF RN 5j ,LK 1/2 jun RN ,M LK 2/1 jun RN				
26	Hannes Bolz	LK 1A	BAWÜ	Stedys Little Wimpy	QH
	LK 1/2 jun RN ,M LK 2/1 jun RN ,YS RN 6j				
27	Katja Geißinger	LK 2A	BAWÜ	A Cowboy By Heart	QH
	JUPF BA 4j ,JUPF RR 4j ,JUPF TH 4j ,LK 2 jun WPL				
28	Rebecca Hansmann	LK 3A	BAWÜ	Rockin My Life	QH
	LK 3A SSH ,LK 3A TH ,LK 3A WPL ,LK 3A WRR				
29	Samantha Gernhardt	LK 3B	BAWÜ, BAY	Catastrophyboonsmal	QH/PH
	LK 1-3 B SSH ,LK 1-3 B TH ,LK 1-3 B WHS ,LK 1-3 B WPL ,LK 1-3B RR ,LK 1-3B WRR				
30	Selina Freund	LK 2A	BAWÜ	Top Dun Wonder	QH
	LK 1/2 A sen SUHO ,LK 2A sen RR ,LK 2A sen WR ,LK 2A sen WRR ,M LK 2/1 A sen RR ,M LK 2/1 A sen SUHO ,M LK 2/1A sen WR ,M LK 2/1A sen WRR				
31	Gesa Meier-Bidmon	LK 2A	BAWÜ	Magic Blue Touch	QH
	LK 2 jun TH ,LK 2 jun WR ,M LK 2/1 jun TH ,M LK 2/1 jun WR ,YS CH 6j				
32	Maren Funke	LK 3A	BAWÜ	My Artful Investment	QH
	JUPF BA 5j ,JUPF TH 5j ,LK 3A WHS				
33	Tim Tuscher	LK 1A	BAWÜ	Suisse Chocolate	QH
	LK 1A sen RN ,M LK 2/1 A sen RN				
34	Shirin Leber	LK 3A	BAWÜ	GS MISS SPANISH	QH
	LK 3A RN ,YS CH 6j ,YS RN 6j				
35	Amely Wiedenmayer	LK 3B	BAWÜ	She Is A Yankee Kid	QH
	LK 1-3 B RN ,LK 1-3 B SSH ,LK 1-3 B TH ,LK 1-3 B WHS ,LK 1-3 B WPL ,LK 1-3B RR ,LK 1-3B WRR				
36	Diana Kirschner-Kurz	LK 3A	BAWÜ	Josie	TI
	LK 3A SSH ,LK 3A TH ,LK 3A WRR				
37	Kerstin Rutsch	LK 1A	BAWÜ	Take Your Gun For Me	QH
	LK 1A sen RN ,LK 1A sen RR ,LK 1A sen WRR ,M LK 2/1 A sen RN ,M LK 2/1 A sen RR ,M LK 2/1A sen WRR				
38	Kerstin Rutsch	LK 1A	BAWÜ	Hollywoods Wallaflash	PH
	JUPF BA 4j ,JUPF RN 4j ,JUPF RR 4j ,LK 1 jun RR ,LK 1 jun WRR ,LK 1/2 jun RN ,M LK 2/1 jun RN ,M LK 2/1 jun RR ,M LK 2/1 jun WRR				
39	Lisa Kehrer	LK 2A	BAWÜ	LS Sugarman Dazz	APP
	LK 2A sen RR ,LK 2A sen TH ,LK 2A WHS ,M LK 2/1 A sen TH				
40	Eileen Przemus	LK 3A	BAWÜ	EH First Finest Jess	QH
	JUPF BA 4j ,JUPF RR 4j ,JUPF TH 4j				
41	Nadja Liebig	LK 1A	BAWÜ	Enjoy My Motion	QH
	LK 1A WHS ,M LK 2/1 A sen TH ,M LK 2/1 A sen WPL ,M LK 2/1 A WHS				
42	Nadine Ketterer	LK 2A	BAWÜ	Dun Dream Hailey	QH
	LK 1/2 A SSH ,LK 2A sen RR ,LK 2A sen WPL ,LK 2A sen WRR ,LK 2A WHS ,M LK 2/1 A sen RR ,M LK 2/1 A SSH ,M LK 2/1A sen WRR				
43	Sarah Sporleder	LK 1A	RLP, BAWÜ	TFR Only In My Dream	QH
	JUPF BA 5j ,JUPF RR 5j ,JUPF TH 5j ,LK 1 jun TH ,M LK 2/1 jun TH ,M LK 2/1 jun WPL				

**EWU Turnier: Landesmeisterschaft EWU Baden-Württemberg**

44 Susanne Ehrle	LK 2A	BAWÜ	TC Megas Rocky	QH
LK 1/2 A SSH ,LK 2A sen RR ,LK 2A sen TH ,LK 2A sen WPL ,LK 2A sen WRR ,LK 2A WHS ,M LK 2/1 A sen TH ,M LK 2/1 A sen WPL ,M LK 2/1 A SSH ,M LK 2/1A sen WRR ,YS CH 7j				
45 Marlene Sofie Ege	LK 3B	BAWÜ	Amanda Hickory Gun	PH
LK 1-3 B SSH ,LK 1-3 B TH ,LK 1-3 B WHS ,LK 1-3 B WPL ,LK 1-3B RR ,LK 1-3B WRR				
46 Rebecca Rosalie Schmid	LK 3A	BAWÜ	HQ Good Little Moon	QH
LK 3A RR ,LK 3A TH ,LK 3A WRR				
47 Anna-Sophie Salwig	LK 3A	BAWÜ	Dual Smart System	QH
LK 3A RR ,LK 3A SSH ,LK 3A TH ,LK 3A WHS ,LK 3A WPL ,LK 3A WRR				
48 Sabrina Fehrenbach	LK 3A	BAWÜ	COLONELS CLYDE	PH
JUPF BA 4j ,JUPF RN 4j ,JUPF RR 4j ,LK 3A RN ,LK 3A RR				
49 Stefanie Kuhn	LK 1A	BAWÜ	Rockin My Life	QH
JUPF BA 5j ,JUPF TH 5j ,M LK 2/1 jun WRR				
50 Nick Kalka	LK 2A	BAWÜ	A Genuine Playgirl	QH
LK 2A sen RN ,LK 2A sen RR ,LK 2A sen WR ,M LK 2/1 A sen RN ,M LK 2/1A sen WR ,YS CH 7j ,YS RN 7j				
51 Desiree Gröger-Dick	LK 2A	BAWÜ	HC Born to Shine	QH
LK 2 jun WPL ,LK 2 jun WRR ,M LK 2/1 jun WPL ,M LK 2/1 jun WRR				
52 Nadine Walz	LK 3A	BAWÜ	HQ Hot Commander	QH
LK 3A SSH ,LK 3A TH ,LK 3A WHS ,LK 3A WPL				
53 Nadine Holl	LK 1A	RLP	Snowfire Sensation	PH
LK 1/2 A SSH ,M LK 2/1 A sen WPL ,M LK 2/1 A SSH				
54 Tamara Kless	LK 1A	BAWÜ	Hot Cielo Blues	QH
M LK 2/1 A sen TH ,M LK 2/1 A sen WPL ,M LK 2/1 A WHS ,M LK 2/1A sen WR				
55 Larissa Heinle	LK 2A	BAWÜ	Nite Owl Early Blues	QH
LK 1/2 A SSH ,LK 2A sen TH ,LK 2A sen WPL ,LK 2A WHS ,M LK 2/1 A sen TH ,M LK 2/1 A sen WPL				
56 Matthias Fischer	LK 3A	BAWÜ	Will Finds A Way	QH
JUPF BA 5j ,JUPF RR 5j ,JUPF TH 5j				
57 Andrew Pluntke	LK 2A	BAWÜ	HQH Justly S Badger	QH
LK 1/2 A sen SUHO ,LK 2A sen RR ,LK 2A sen TH ,LK 2A sen WR ,LK 2A sen WRR ,LK 2A WHS ,M LK 2/1 A sen SUHO ,M LK 2/1 A sen TH ,M LK 2/1 A WHS ,M LK 2/1A sen WRR				
58 Simone Frank	LK 1A	BAWÜ	Suddenly A Romance	QH
LK 1 jun TH ,LK 1 jun WPL ,LK 1 jun WR ,M LK 2/1 jun RR ,M LK 2/1 jun TH ,M LK 2/1 jun WPL ,M LK 2/1 jun WR ,YS CH 6j				
59 Vanessa Beck	LK 2A	BAWÜ	LR Talk About Saint	QH
LK 1/2 A SSH ,LK 2A sen RR ,LK 2A sen TH ,LK 2A sen WRR ,LK 2A WHS ,M LK 2/1 A sen RR ,M LK 2/1 A sen TH ,M LK 2/1 A SSH ,M LK 2/1A sen WRR				
60 Diana Ott	LK 1A	BAWÜ	Coeur D Knick Nic	QH
LK 1/2 A sen SUHO ,LK 1A sen RR ,LK 1A sen TH ,M LK 2/1 A sen RR ,M LK 2/1 A sen SUHO ,M LK 2/1 A sen TH ,M LK 2/1 A WHS ,M LK 2/1A sen WR				
61 Tobias Wolfer	LK 2A	BAWÜ	Saturday Olena	QH
LK 1/2 A sen SUHO ,LK 2A sen RN ,LK 2A sen RR ,LK 2A sen WRR ,M LK 2/1 A sen RR ,M LK 2/1 A sen SUHO ,M LK 2/1A sen WRR				
62 Gesa Meier-Bidmon	LK 2A	BAWÜ	Cinderella Blues	QH
LK 2 jun TH ,LK 2 jun WPL ,M LK 2/1 jun TH ,M LK 2/1 jun WPL				
63 Johanna Kreß	LK 3B	BAWÜ	Solanos Whiskey	QH
LK 1-3 B TH ,LK 1-3 B WPL ,LK 3B WR ,YS RN 6j				
64 Johanna Kreß	LK 3B	BAWÜ	Spats Night Glo	QH
LK 1-3 B RN ,LK 1-3B RR ,LK 1-3B WRR				
65 Marie-Jo Schmegner	LK 3A	BAWÜ	Awesome on Ice	QH
LK 3A SSH ,LK 3A TH ,LK 3A WHS ,LK 3A WPL				

# TEILNEHMER

## EWU Turnier: Landesmeisterschaft EWU Baden-Württemberg

66 Sandra Ruml-Mayer M LK 2/1 A sen TH ,M LK 2/1A sen WR	LK 1A	BAWÜ	Larks Zippo Sue	QH
67 Uwe Hohn LK 2A sen TH ,LK 2A sen WPL ,LK 2A WHS ,M LK 2/1 A sen TH ,M LK 2/1 A sen WPL ,M LK 2/1 A WHS	LK 2A	BAWÜ	Gotta Hot Krymsun	QH
68 Lisa Sporbeck JUPF BA 4j ,JUPF RN 4j ,JUPF RR 4j ,LK 2 jun RR ,M LK 2/1 jun RR	LK 2A	BAWÜ	JS Ruff N Flashy	QH
69 Andreas Holl M LK 2/1 A sen RR ,M LK 2/1 A WHS ,M LK 2/1A sen WRR	LK 1A	RLP	Black Night Star	QH
70 Andreas Holl M LK 2/1 jun RR ,M LK 2/1 jun WRR	LK 1A	RLP	MR Smoking Gun	QH
71 Alena Rohrer M LK 2/1A sen WR	LK 1A	BAWÜ	HR Hollywood Snapper	QH
72 Jürgen Schwarz LK 2A sen RN ,M LK 2/1 A sen RN	LK 2A	BAWÜ	HR Hollywood Snapper	QH
73 Kim Gicklhorn LK 1A sen TH ,LK 1A sen WPL ,LK 1A WHS ,M LK 2/1 A sen TH ,M LK 2/1 A sen WPL ,M LK 2/1 A WHS	LK 1A	BAWÜ	Chips Hot Spark	QH
74 Nina Obermüller JUPF BA 4j ,JUPF RR 4j ,JUPF TH 4j ,LK 1 jun TH ,M LK 2/1 jun WPL	LK 1A	BAWÜ	JQH Style In Motion	QH
75 Leonie Mager LK 1/2 A sen SUHO ,LK 1A sen RR ,LK 1A sen WRR ,M LK 2/1 A sen RR ,M LK 2/1 A sen SUHO ,M LK 2/1A sen WRR	LK 1A	BAWÜ	Ruff Commander	QH
76 Antje Kurz LK 3A RN ,LK 3A WHS ,YS CH 6j ,YS RN 6j	LK 3A	BAWÜ	Special Whiz N Wimp	QH
77 Katrin Strohmeier LK 1/2 A sen SUHO ,LK 1A sen RR ,M LK 2/1 A sen RR ,M LK 2/1 A sen SUHO ,M LK 2/1A sen WRR	LK 1A	BAWÜ	Nu Chex To Nic	QH
78 Michael Neff LK 2A sen RN ,M LK 2/1 A sen RN	LK 2A	BAWÜ	Spirit (221)	WGP
79 Marlene Stauss LK 1 jun TH ,LK 1A WHS ,M LK 2/1 A WHS ,M LK 2/1 jun TH ,M LK 2/1 jun WPL ,YS CH 6j	LK 1A	BAWÜ	Heza Fortune Cookie	QH
80 Marlene Stauss JUPF BA 4j ,JUPF TH 4j ,LK 1 jun TH ,LK 1 jun WPL	LK 1A	BAWÜ	Good Timmy Kruzer	QH
81 Lina Stauß LK 1-3 B SSH ,LK 1-3 B TH ,LK 1-3 B WHS	LK 3B	BAWÜ	Heza Fortune Cookie	QH
82 Nicole Steinbrecher LK 1A sen TH ,LK 1A WHS ,M LK 2/1 A sen TH ,M LK 2/1 A SSH ,M LK 2/1 A WHS	LK 1A	BAWÜ	Will be Famous	QH
83 Ben Fisher LK 1A sen WPL ,LK 1A sen WR ,M LK 2/1 A sen WPL ,M LK 2/1A sen WR	LK 1A	BAWÜ	Will be Famous	QH
84 Ben Fisher JUPF BA 5j ,JUPF TH 5j ,LK 1 jun TH ,M LK 2/1 jun TH	LK 1A	BAWÜ	To Be Only Good	QH
85 Ben Fisher LK 1 jun TH ,LK 1 jun WPL ,LK 1 jun WR ,M LK 2/1 jun TH ,M LK 2/1 jun WPL ,M LK 2/1 jun WR ,YS CH 6j	LK 1A	BAWÜ	The Miracle One	QH
86 Sina Schlaich LK 3A RN ,LK 3A RR ,LK 3A TH ,LK 3A WHS ,LK 3A WPL ,LK 3A WRR	LK 3A	BAWÜ	Gina (1777)	WGP
87 Marisa Abele LK 3A RR ,LK 3A WHS ,LK 3A WPL ,LK 3A WRR	LK 3A	BAWÜ	Sailin Seabiscuit	QH
89 Maja Hinderer LK 1-3 B SSH ,M LK 2/1 B RN ,M LK 2/1 B SSH ,M LK 2/1 B TH ,M LK 2/1 B WHS ,M LK 2/1 B WPL ,M LK 2/1B WR ,M LK 2/1B WRR	LK 1B	BAWÜ	Midnight Mechanics	QH

# TEILNEHMER

## EWU Turnier: Landesmeisterschaft EWU Baden-Württemberg

90 Corinna Klingmann LK 3A RR ,LK 3A SSH ,LK 3A WHS ,LK 3A WPL ,LK 3A WRR	LK 3A	BAWÜ	Sanchero	CR
91 Leni Jansky LK 1-3 B SSH ,LK 1-3 B WHS ,LK 1-3 B WPL ,LK 1-3B RR ,LK 1-3B WRR	LK 3B	BAWÜ	Silver Bo Goldmine	QH
92 Kathrin Ehrfeld LK 2 jun RR ,LK 2 jun TH ,LK 2 jun WPL ,LK 2 jun WRR ,M LK 2/1 jun WPL ,M LK 2/1 jun WRR	LK 2A	BAWÜ	Cats Candy Hancock	PH
93 Lena Bertog LK 1 jun WPL ,LK 1 jun WRR	LK 1A	BAWÜ	Rods Lennard Bourbon	QH
94 Heike Winter LK 1A sen RN ,M LK 2/1 A sen RN	LK 1A	BAWÜ	Don Raffael	QH
95 Carolin Batschkowski LK 3A RR ,LK 3A TH ,LK 3A WHS ,LK 3A WPL ,LK 3A WR ,LK 3A WRR	LK 3A	BAWÜ	Invest N Freckles	PH
96 Nikolaus Winter LK 2A sen RN ,M LK 2/1 A sen RN	LK 2A	BAWÜ	SL Layla Revolution	QH
97 Katharina Strohmaier LK 1A sen RN ,LK 1A sen RR ,M LK 2/1 A sen RN ,M LK 2/1 A sen RR ,M LK 2/1 A sen SUHO ,M LK 2/1A sen WR	LK 1A	BAWÜ	MR Mac Cash	QH
98 Jörg Strohmaier LK 3A RN	LK 3A	BAWÜ	Shine Lika Diamond	QH
99 Nathalie Karger LK 3A RN ,LK 3A RR ,LK 3A TH ,LK 3A WHS ,LK 3A WR	LK 3A	BAWÜ	Wimpys Jeanie Solana	QH
100 Natalie Schreiber LK 2A sen RR ,LK 2A sen WR ,LK 2A sen WRR	LK 2A	BAWÜ	FR Dual Dunit	QH
101 Céline Buss LK 3A TH ,LK 3A WPL ,LK 3A WR	LK 3A	BAWÜ	Good Time Blues	QH
102 Kerstin Pyhrr JUPF BA 5j ,JUPF RN 5j ,JUPF RR 5j ,LK 3A RR ,LK 3A WHS	LK 3A	BAWÜ	Genuine Hot Flame	QH
103 Emily Wenzel LK 1-3 B SSH ,LK 1-3 B WHS ,M LK 2/1 B RN ,M LK 2/1 B sen SUHO ,M LK 2/1 B SSH ,M LK 2/1 B TH ,M LK 2/1 B WHS ,M LK 2/1 B WPL ,M LK 2/1B WR ,M LK 2/1B WRR	LK 2B	BAWÜ	My Genuine Flaxnchex	QH
104 Sabrina Reiff LK 1/2 A sen SUHO ,LK 1A sen RN ,LK 1A sen RR ,LK 1A sen TH ,LK 1A sen WRR ,LK 1A WHS ,M LK 2/1 A sen SUHO ,M LK 2/1 A sen TH ,M LK 2/1 A WHS ,M LK 2/1A sen WR ,M LK 2/1A sen WRR	LK 1A	BAWÜ	One Hollywood Dunit	QH
105 Barbara Heiter LK 1A sen TH ,LK 1A sen WPL ,LK 1A sen WR ,LK 1A WHS ,M LK 2/1 A sen TH ,M LK 2/1 A sen WPL ,M LK 2/1 A WHS ,M LK 2/1A sen WR	LK 1A	BAWÜ	Rap My Blues	QH
106 Barbara Heiter JUPF BA 5j ,JUPF TH 5j ,LK 1 jun TH ,LK 1 jun WPL ,M LK 2/1 jun WPL	LK 1A	BAWÜ	Sheza Fortune Cookie	QH
107 Tim Tuscher JUPF BA 4j ,JUPF RN 4j ,JUPF RR 4j	LK 1A	BAWÜ	My First Buckskin	QH
108 Tim Tuscher JUPF BA 5j ,JUPF RN 5j ,JUPF RR 5j ,LK 1/2 jun RN ,M LK 2/1 jun RN ,M LK 2/1 jun RR ,M LK 2/1 jun WRR	LK 1A	BAWÜ	Dr Voodoo Shiney	QH
109 Tim Tuscher LK 1A sen RN ,M LK 2/1 A sen RN ,M LK 2/1A sen WRR ,YS RN 7j	LK 1A	BAWÜ	Smart Spooks Jolene	QH
110 Christina Scheiter LK 3A RR ,YS CH 7j ,YS RN 7j	LK 3A	BAWÜ	Smart Classic Shine	QH
111 Severine Stehling JUPF RR 4j ,JUPF TH 4j	LK 2A	BAWÜ	Little Tom Blackburn	QH



# PREMIUM-SPONSOREN

# TEILNEHMER



## EWU Turnier: Landesmeisterschaft EWU Baden-Württemberg

112 Jördis Ziller JUPF BA 4j ,LK 3A SSH	LK 3A	BAWÜ	Little Tom Blackburn	QH
113 Antonia Wiedenmayer JUPF BA 5j ,JUPF RR 5j ,JUPF TH 5j ,LK 1-3B RR	LK 3B	BAWÜ	Mergellina Whiz	QH
114 Leonie Franziska Pautz LK 1A sen TH ,LK 1A sen WPL ,LK 1A WHS ,M LK 2/1 A sen TH ,M LK 2/1 A sen WPL	LK 1A	BAWÜ	Gotta Hot Potential	QH
115 Vanja Rau LK 1/2 A SSH ,M LK 2/1 A SSH	LK 2A	BAWÜ	Chips Hot Spark	QH
116 Daniela Ziegelbauer JUPF TH 4j ,LK 3A SSH	LK 3A	BAWÜ	XpectedGoodImpulsion	QH
117 Fabienne Luttenberger LK 3A RR ,LK 3A TH ,LK 3A WHS ,LK 3A WPL ,LK 3A WRR	LK 3A	BAWÜ	Bueno Chicolino	QArb
118 Alana Strohmaier LK 1A sen RR ,LK 1A sen WR ,M LK 2/1 A sen SUHO ,M LK 2/1 A sen TH ,M LK 2/1A sen WR	LK 1A	BAWÜ	JS Emi Jac	QH
119 Alana Strohmaier M LK 2/1 A sen RR ,M LK 2/1 A WHS ,M LK 2/1A sen WRR	LK 1A	BAWÜ	Shine Lika Diamond	QH
120 Stefanie Kuhn JUPF BA 4j	LK 1A	BAWÜ	XpectedGoodImpulsion	QH
121 Stefanie Kuhn M LK 2/1 A SSH	LK 1A	BAWÜ	Larks Zippo Sue	QH
122 Stefanie Kuhn M LK 2/1 jun TH ,YS CH 6j	LK 1A	BAWÜ	HC Born to Shine	QH
123 Manuela Gast JUPF RN 5j ,JUPF RR 5j ,LK 1/2 jun RN ,LK 2 jun RR ,LK 2 jun WRR ,M LK 2/1 jun RN ,M LK 2/1 jun WRR	LK 2A	BAWÜ	Elta Dunit Mercedes	QH
124 Celine Beisel LK 1A sen RN ,M LK 2/1 A sen RN	LK 1A	BAWÜ, HES	ND SHINING DIAMOND	QH
125 Ferenc Füssel LK 1A sen RN ,M LK 2/1 A sen RN	LK 1A	BAWÜ	BF Gunstein	QH/PH
126 Ferenc Füssel JUPF RN 4j ,LK 1/2 jun RN ,M LK 2/1 jun RN	LK 1A	BAWÜ	Twisten Cool Socks	QArb
127 Samara Breithaupt LK 1-3 B WHS ,LK 1-3 B WPL ,LK 1-3B RR ,LK 1-3B WRR ,LK 3B WR	LK 3B	BAWÜ	Lil Whiz N It	QH
128 Sarah Betz LK 2A sen TH ,LK 2A sen WPL ,LK 2A WHS	LK 2A	BAWÜ	Hulapalu Onlywithyou	QH
129 Jessica Prokop LK 1/2 A sen SUHO ,LK 1A sen RN ,LK 1A sen RR ,LK 1A sen TH ,LK 1A sen WRR ,M LK 2/1 A sen RR ,M LK 2/1 A sen TH ,M LK 2/1A sen WRR	LK 1A	BAWÜ	You Shine On Me	APP
130 Theresa Hossinger LK 1-3 B RN ,LK 1-3B RR ,M LK 2/1 B RN ,M LK 2/1 B RR ,YS RN 7j	LK 2B	BAWÜ	Dont Cry Roxy	QH
131 Michaela König LK 3A RR ,LK 3A TH ,LK 3A WHS ,LK 3A WPL ,LK 3A WRR	LK 3A	BAWÜ	Gunhills Mouse	QH
132 Franziska Haug LK 1/2 A sen SUHO ,LK 1A sen RN ,LK 1A sen RR ,LK 1A sen WRR ,M LK 2/1 A sen RN ,M LK 2/1 A sen RR ,M LK 2/1 A sen SUHO ,M LK 2/1A sen WRR	LK 1A	BAWÜ	Chic N Shiny	QH
133 Jana Haug LK 1 jun WRR ,M LK 2/1 jun RN ,M LK 2/1 jun RR ,M LK 2/1 jun WR ,M LK 2/1 jun WRR ,YS CH 6j ,YS RN 6j	LK 1A	BAWÜ	One Soldier Army	QH
134 Sara Marchetti M LK 2/1 B RR ,M LK 2/1 B TH ,M LK 2/1 B WHS ,M LK 2/1B WRR	LK 2B	BAWÜ	Big Step Cathy Jane	PH

# TEILNEHMER

## EWU Turnier: Landesmeisterschaft EWU Baden-Württemberg

135 Isabel Schertle	LK 1A	BAWÜ, BAY	Big Beckwiths Time	QH
LK 1/2 A sen SUHO ,LK 1A sen RR ,LK 1A sen TH ,LK 1A sen WR ,LK 1A WHS ,M LK 2/1 A sen RR ,M LK 2/1 A sen SUHO ,M LK 2/1 A sen TH ,M LK 2/1 A WHS ,M LK 2/1A sen WR				
136 Nadja Liebig	LK 1A	BAWÜ	AM Diesel Perfection	QH
JUPF BA 5j ,JUPF TH 5j				
137 Michael Mützel	LK 1A	BAWÜ	Smart Pretty Socks	QH
LK 1 jun RR ,LK 1 jun TH ,LK 1 jun WR ,M LK 2/1 jun RR ,M LK 2/1 jun TH ,M LK 2/1 jun WPL ,M LK 2/1 jun WR ,YS CH 6j				
138 Yasmin Werner	LK 2A	BAWÜ	Mi Bandido	CR
LK 2A sen RR ,LK 2A sen TH ,LK 2A sen WRR ,LK 2A WHS ,M LK 2/1 A sen TH ,M LK 2/1A sen WRR				
139 Lisa Dölling	LK 2A	HES	ND Cash The Guns	QH
JUPF BA 4j ,JUPF RN 4j ,JUPF RR 4j				
140 Ina Wiedemann	LK 1A	BAWÜ	Twisted Daylight	QH
LK 1A sen RR ,LK 1A WHS ,M LK 2/1 A sen RR ,M LK 2/1 A sen TH ,M LK 2/1 A sen WPL ,M LK 2/1 A WHS ,M LK 2/1A sen WR				
141 Jana Theß	LK 3A	BAWÜ	CSH Spanish Ruby	PH
JUPF BA 4j ,JUPF RN 4j ,JUPF RR 4j ,LK 3A WHS ,LK 3A WRR				
142 Sonja Colditz	LK 3A	BAWÜ	Manolito Incauto	CR
LK 3A RR ,LK 3A WHS ,LK 3A WRR				
143 Sarah Bucher	LK 1A	BAWÜ, HES	Pegtoboonsmal	QH
LK 1A sen RR ,M LK 2/1 A sen RR				
144 Sarah Bucher	LK 1A	BAWÜ, HES	Magic Star Revolution	PH
LK 1A sen RR ,M LK 2/1 A sen RR ,M LK 2/1A sen WRR				
145 Tanja Lehmann	LK 3A	BAWÜ	soldiers finest	QH
JUPF BA 5j ,JUPF RR 5j ,JUPF TH 5j ,LK 3A RR				
146 Stefanie Müller	LK 2A	BAWÜ	Miss Jacky Peppels	PH
LK 1/2 A SSH ,LK 2A sen TH ,LK 2A sen WPL ,LK 2A WHS ,M LK 2/1 A sen WPL ,M LK 2/1 A SSH				
147 Anna Göggel	LK 1A	BAWÜ	RS Hermes Olena	QH
LK 1A sen RR ,LK 1A sen WRR ,LK 1A WHS ,M LK 2/1 A sen RR ,M LK 2/1 A WHS ,M LK 2/1A sen WRR				
148 Stefan Raab	LK 3A	BAWÜ	HW Roosters Sally	QH
LK 3A RR ,LK 3A TH ,LK 3A WHS ,LK 3A WPL ,LK 3A WRR				
149 Tanja Knopp	LK 2A	BAWÜ	GRR Aint It Perfect	QH
JUPF BA 4j ,JUPF TH 4j ,LK 2 jun WPL ,M LK 2/1 jun WPL				
150 Kristin Schäfer	LK 3A	BAWÜ	Cayuse	QH
LK 3A RR ,LK 3A TH ,LK 3A WHS				
151 Bianka Rettenmaier	LK 3A	BAWÜ	FR Blues Diamond	QH
LK 3A RR ,LK 3A TH ,LK 3A WHS ,LK 3A WPL				
152 Tabea Christine Steinger	LK 3A	BAWÜ	You Shine On Me	APP
LK 3A RR ,LK 3A TH ,LK 3A WHS ,LK 3A WPL ,LK 3A WRR				
153 Julia Schuster	LK 3A	BAWÜ	Big Beckwiths Time	QH
LK 3A TH ,LK 3A WHS				
154 Lena Hättich	LK 2A	BAWÜ	Whiza Shina Sky	QH
JUPF RN 4j ,JUPF RR 4j ,JUPF TH 4j ,LK 1/2 jun RN ,LK 2 jun RR				
155 Nadine Karsten	LK 3A	RLP	PB Benito Lena	PH
JUPF BA 4j ,LK 3A WHS				
156 Lisa-Marie Reiff	LK 2A	BAWÜ	Skylight Commander	QH
JUPF BA 4j ,JUPF RR 4j ,JUPF TH 4j				
157 Leonie Schädler	LK 2A	BAWÜ	Sto Joe Whiskey	QH
JUPF BA 4j ,JUPF RR 4j ,JUPF TH 4j ,M LK 2/1 jun RR ,M LK 2/1 jun WRR				

# TEILNEHMER

## EWU Turnier: Landesmeisterschaft EWU Baden-Württemberg

158 Daniela Breithaupt	LK 3A	BAWÜ	Skip A Gun	APP
JUPF BA 4j ,JUPF RR 4j ,LK 3A WPL				
159 Sarah Nufer	LK 2A	BAWÜ	Dressed By MDS Pingo	QH
LK 2A sen RN ,LK 2A sen RR ,LK 2A sen WRR ,M LK 2/1 A sen RR ,M LK 2/1A sen WRR				
160 Lena Hättich	LK 2A	BAWÜ	Whiskey To Cash	QH
LK 1/2 jun RN ,LK 2 jun WRR ,M LK 2/1 jun RN ,M LK 2/1 jun RR ,YS CH 6j ,YS RN 6j				
161 Karlotta Kern	LK 3A	BAWÜ	Dunits Hot Shot	QH
LK 3A WHS				
162 Lea Maria Ernemann	LK 3B	BAWÜ	Bambi Star Jet	PH
LK 1-3 B WHS ,LK 1-3B RR				
163 Dunja Ernemann	LK 3A	BAWÜ	Bambi Star Jet	PH
LK 3A RR ,LK 3A WHS				
164 Isabel Schertle	LK 1A	BAWÜ, BAY	One Spook N Card	QH
LK 1/2 A sen SUHO ,LK 1A sen RN ,M LK 2/1 A sen RN ,M LK 2/1 A sen SUHO				
165 Lena Zimmermann	LK 2A	BAWÜ	Chics Black Taris	QH
LK 2A sen TH ,M LK 2/1 A sen TH				
166 Nicolai Schuller	LK 2A	BAWÜ	Fly's Lily Of The Valley	QHM
M LK 2/1 jun RR ,M LK 2/1 jun TH ,M LK 2/1 jun WRR				
167 Verena Lukoschek	LK 1A	BAWÜ	Only Invitation Skip	QH
JUPF BA 5j ,JUPF TH 5j ,LK 1 jun TH				
168 Verena Lukoschek	LK 1A	BAWÜ	Tivio Higgins Sport	QH
LK 1A sen TH ,M LK 2/1 A sen TH ,M LK 2/1 A WHS ,M LK 2/1A sen WRR				
169 Martina Bürkle	LK 1A	BAWÜ	Joyrides Harry Bu	QH
LK 1A sen RR ,LK 1A sen TH ,LK 1A sen WRR ,LK 1A WHS ,M LK 2/1 A sen TH ,M LK 2/1 A WHS ,M LK 2/1A sen WRR				
170 Johannes Taxis	LK 3A	BAY	One Spook N Card	QH
LK 3A RN ,LK 3A RR ,LK 3A TH ,LK 3A WRR				
171 Martina Bürkle	LK 1A	BAWÜ	Thisguysnotforsale	QH
JUPF BA 5j ,JUPF TH 5j ,LK 1 jun TH ,LK 1 jun WPL ,M LK 2/1 jun TH ,M LK 2/1 jun WPL				
172 Cora Marie Denzinger	LK 3B	BAWÜ	Joyrides Harry Bu	QH
LK 1-3 B TH ,LK 1-3 B WHS ,LK 1-3 B WPL ,LK 1-3B WRR				
173 Mia Ruthardt	LK 1B	BAWÜ	Royal Chipped Foxy	QH
M LK 2/1 B TH ,M LK 2/1 B WHS ,M LK 2/1 B WPL				
174 Celina Schuller	LK 1B	BAWÜ	Mistery Flight	WGP
M LK 2/1 B RR ,M LK 2/1 B TH ,M LK 2/1 B WHS				
175 Diana Ruthardt	LK 2A	BAWÜ	Royal Chipped Foxy	QH
LK 2A sen RR ,LK 2A sen TH ,LK 2A sen WPL ,LK 2A WHS				
176 Ferenc Füssel	LK 1A	BAWÜ	JM Whiz N Step	QH
JUPF BA 5j ,JUPF RN 5j ,JUPF RR 5j				
177 Ferenc Füssel	LK 1A	BAWÜ	MDH One Spat Gun (Teddy)	PH
JUPF RN 4j ,JUPF RR 4j ,M LK 2/1 jun RN ,M LK 2/1 jun RR				
178 Stefanie Kuhn	LK 1A	BAWÜ	One Great Shining	QH
JUPF RR 5j				
179 Lena Chiara Stuba	LK 2A	BAWÜ	Petas Flashy Crumble	QH
LK 2 jun TH ,LK 2 jun WPL ,M LK 2/1 jun RR ,M LK 2/1 jun TH ,M LK 2/1 jun WPL				

# PREMIUM-SPONSOREN

# PATTERNLISTE



Donnerstag		Freitag		Samstag		Sonntag	
Prüfung	Pattern	Prüfung	Pattern	Prüfung	Pattern	Prüfung	Pattern
sen.LK1A TH	Set3 #1	LK3A RR	#24	LK3A SSH	#13	M2/1B TH	Set6 #4
sen.LK2A TH	Set3 #1	jun.LK1A RR	#20	LK1-3B SSH	#13	M2/1jun.TH	Set6 #4
LK1-3B TH	Set3 #3	jun.LK2A RR	#20	LK1/2A SSH	#20	M2/1sen.TH	Set6 #2
jun.LK1A TH	Set3 #3	sen.LK1A RR	#11	M2/1A SSH	#15	Jupf RN 4j	#1
jun.LK2A TH	Set3 #3	sen.LK2A RR	#11	M2/1B SSH	#15	Jupf RN 5j	#1
LK3A TH	Set3 #3	LK1-3B RR	#20	YS RN 6j	#6	M2/1B WHS	#26
sen.LK1A WR	#3	Jupf Basis 4j	#2	YS RN 7j	#6	M2/1A WHS	#26
sen.LK2A WR	#3	Jupf Basis 5j	#2	M2/1B RN	#10	M2/1A sen.RR	#11
jun.LK1A WR	#5	LK1A WHS	#8	Jupf TH 4j	#1	M2/1B RR	#11
jun.LK2A WR	#5	LK2A WHS	#8	Jupf TH 5j	#2	M2/1A jun.RR	#15
LK3A WR	#5	LK1-3B WHS	Zeichnung	M2/1Asen. WR	#11		
LK3B WR	#5	LK3A WHS	Zeichnung	M2/1B WR	#13		
LK1/2A SUHO	#1	YS CH 6j	#3	M2/1A jun. WR	#13		
Jupf RR 4j	#3	YS CH 7j	#3	M2/1A sen. RN	#10		
Jupf RR 5j	#4	LK3A RN	#8	M2/1A jun.RN	#8		
		LK1-3B RN	#6				
		sen.LK1A RN	#2				
		sen.LK2A RN	#2				
		jun. LK1/2A RN	#6				
		M2/1B Suho	#7				
		M2/1A Suho	#7				

# PATTERN

Pattern sen. Trail - Set 3 - #1 - LK 1/2 **A**

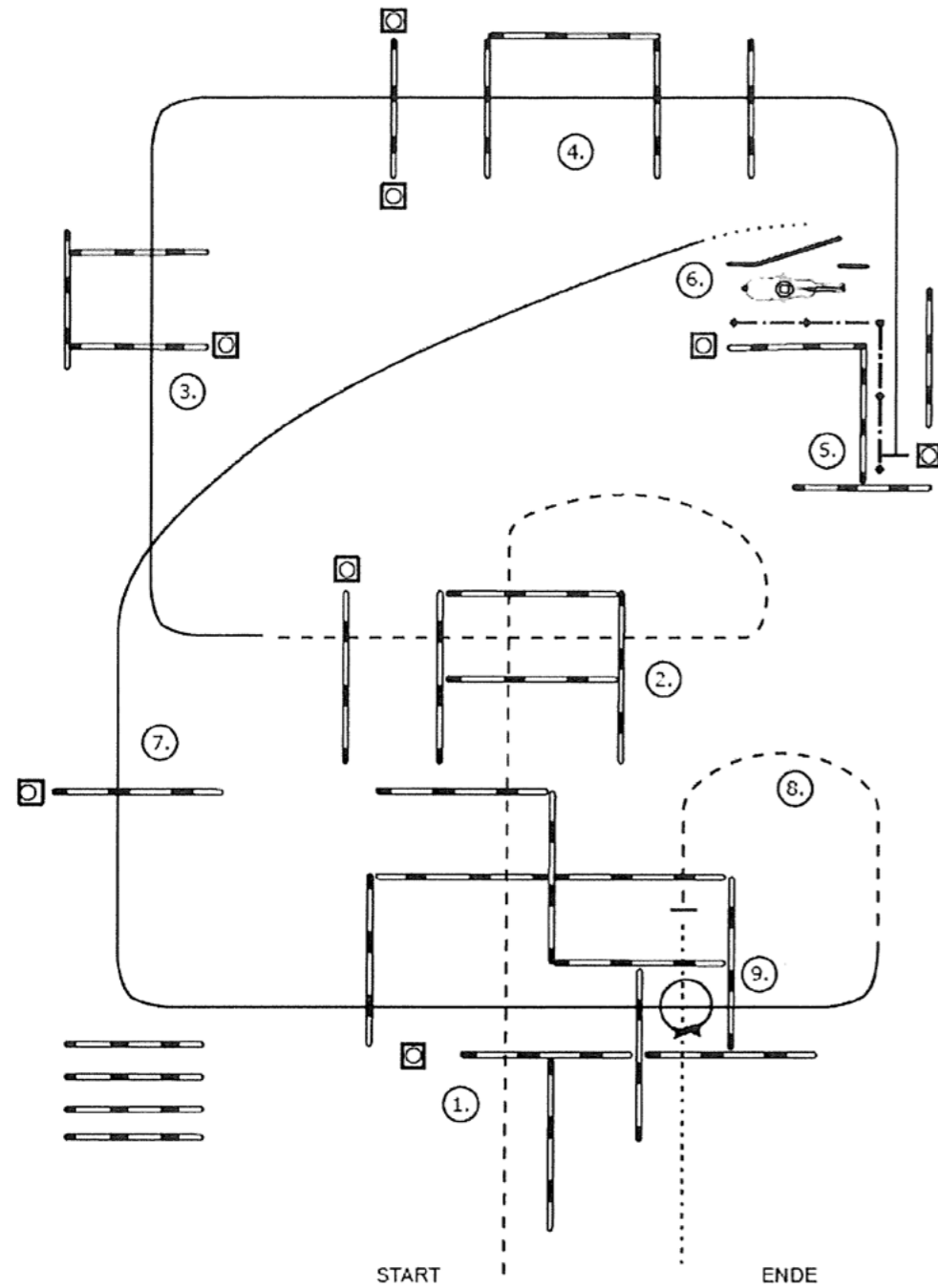

- (1) Jog over
- (2) Jog over
- (3) Lope (Rechtsgalopp)
- (4) Lope over (Rechtsgalopp), Lope in, Stop
- (5) Back up
- (6) Tor
- (7) Walk, Lope over (Linksgalopp)
- (8) Jog in, Stop
- (9) Walk in, 360° Turn (rechts o links), Walk out

# PATTERN

Pattern jun. Trail - Set 3 - #3 - LK 1/2 **A, LK 3 A**  
**LK 1-3 B**

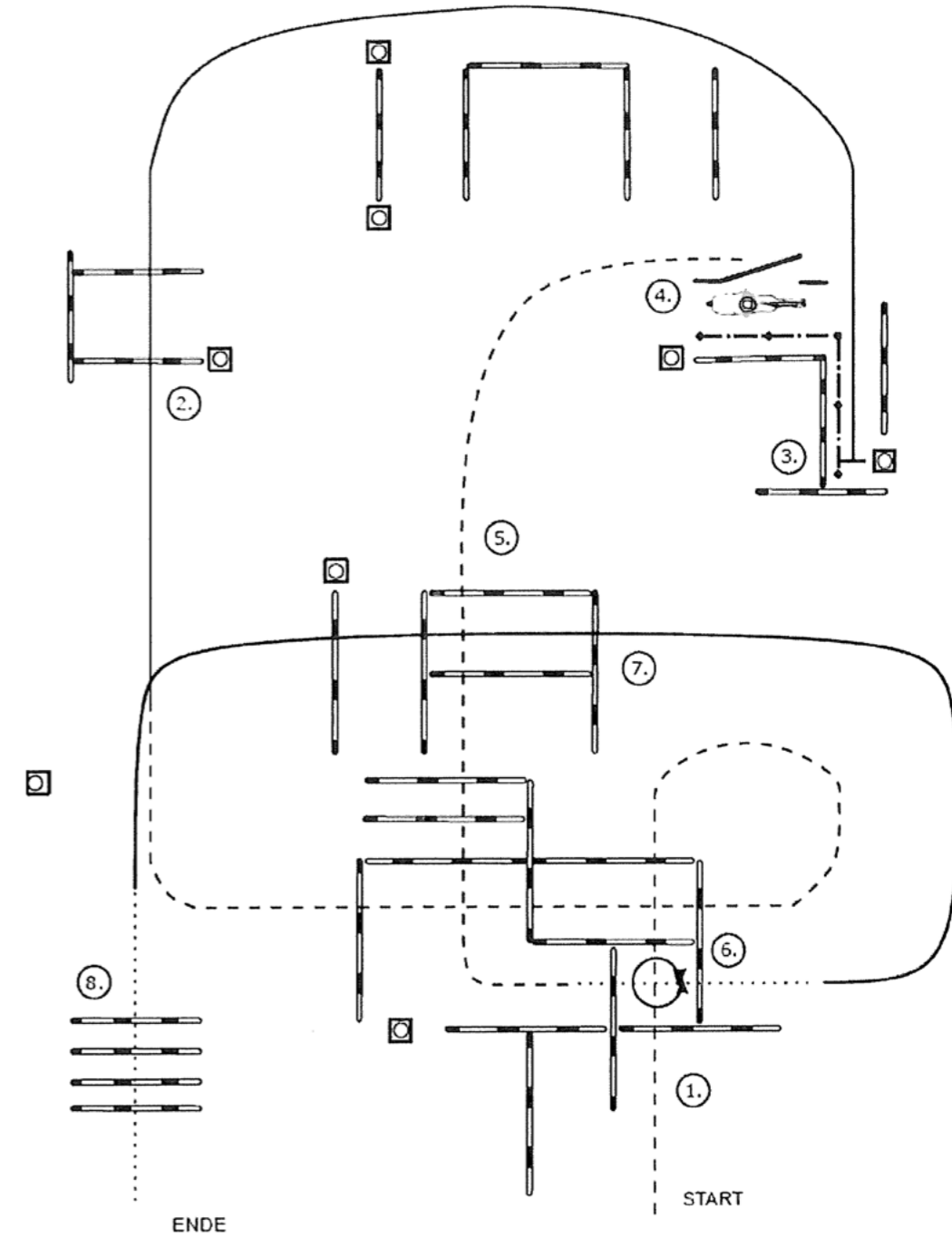

- (1) Jog over
- (2) Lope over (Rechtsgalopp), Lope in, Stop
- (3) Back up
- (4) Tor
- (5) Jog over
- (6) Stop oder Übergang zum Walk, Walk in, 360° Turn (rechts o links), Walk out
- (7) Lope over (Linksgalopp)
- (8) Walk over



# PATTERN

#11 Ranch Riding

sen. LK 1/2 A

min. 20 x 40 Meter

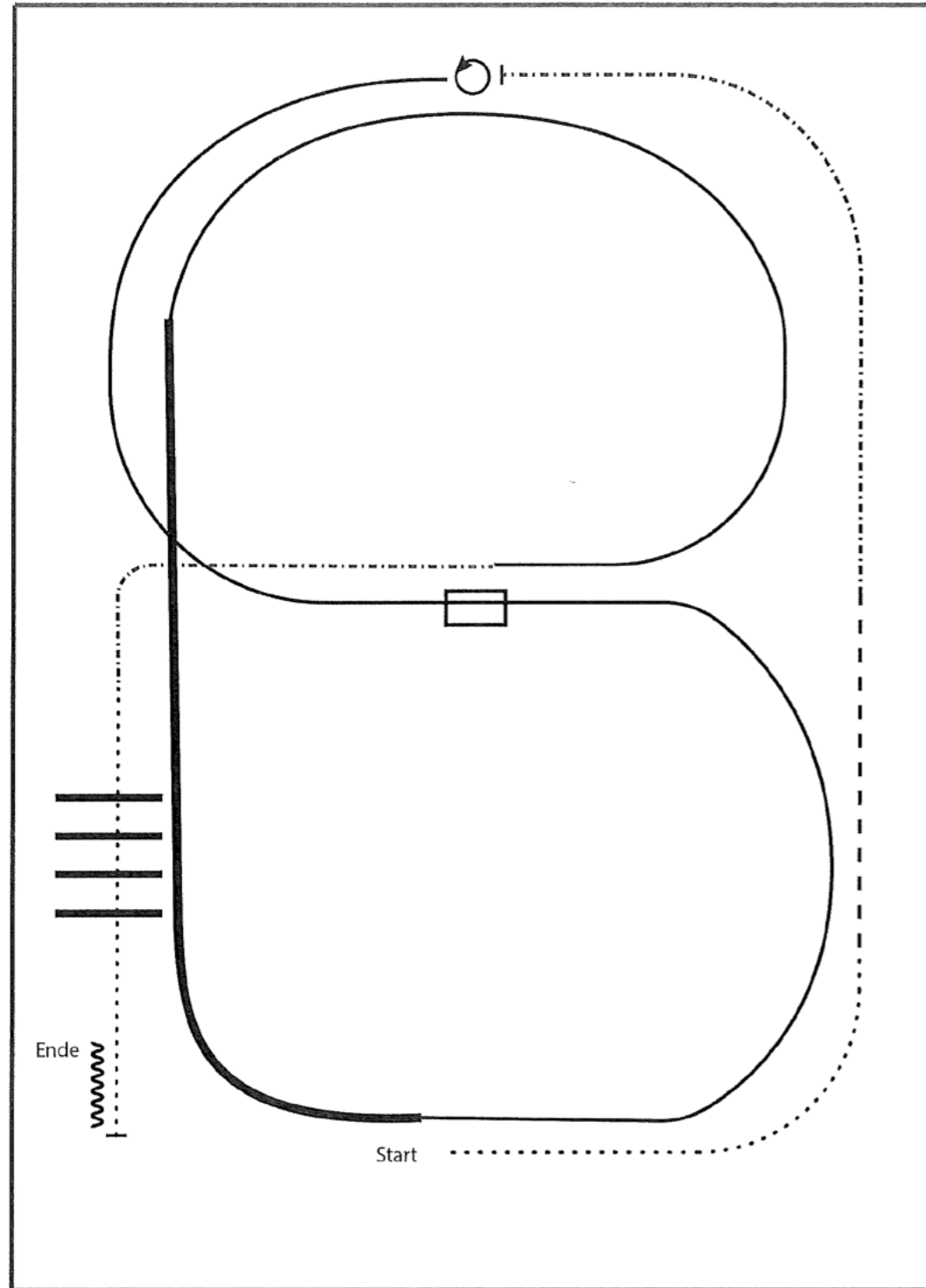

- 1) WALK
- 2) TROT
- 3) EXTENDED TROT, STOP
- 4) 360° TURN LEFT
- 5) LOPE LL
- 6) CHANGE LEADS (SIMPLE OR FLYING)
- 7) LOPE RL
- 8) EXTENDED LOPE RL
- 9) LOPE RL
- 10) EXTENDED TROT
- 11) WALK OVER
- 12) STOP, BACK UP

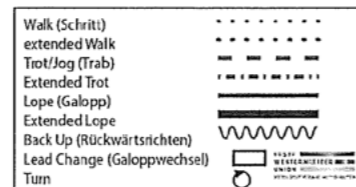

# PATTERN

Pattern W+S - #8 - LK 1/2 A

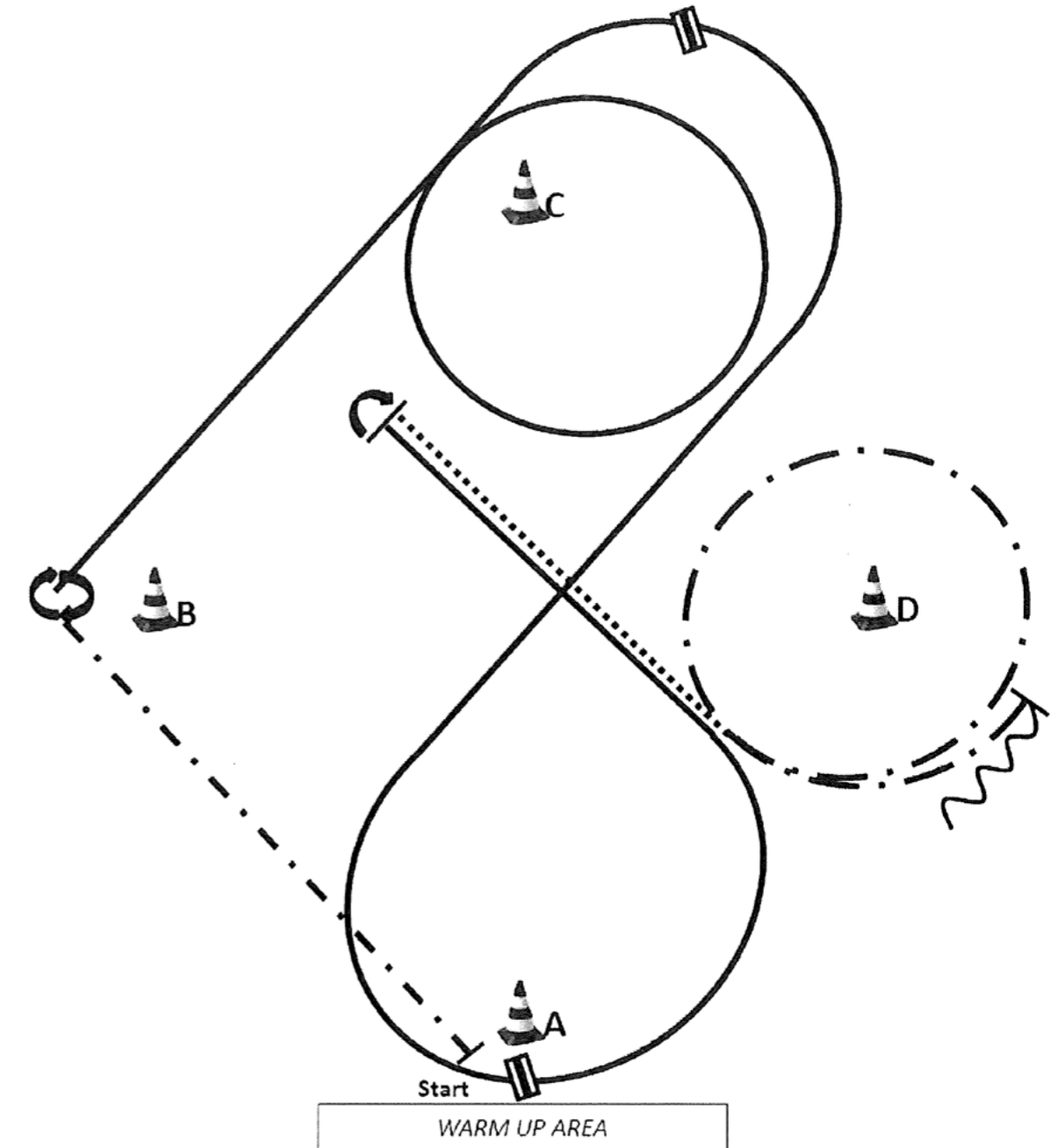

- (1) Start bei A, Extended Jog bis hinter B
- (2) Stop, 450° Turn rechts
- (3) Rechtsgalopp um C
- (4) Rechtsgalopp, Galoppwechsel (fliegend oder einfach),
- (5) Linksgalopp um A
- (6) Galoppwechsel (fliegend oder einfach),
- (7) Rechtsgalopp
- (8) Stop, 180° Turn links, Walk
- (9) Extended Jog um D
- (10) Stop, Back up eine Pferdelänge, Stop  
Im Walk in den Warm-up-Bereich

# BASIS-SPONSOREN

# PATTERN

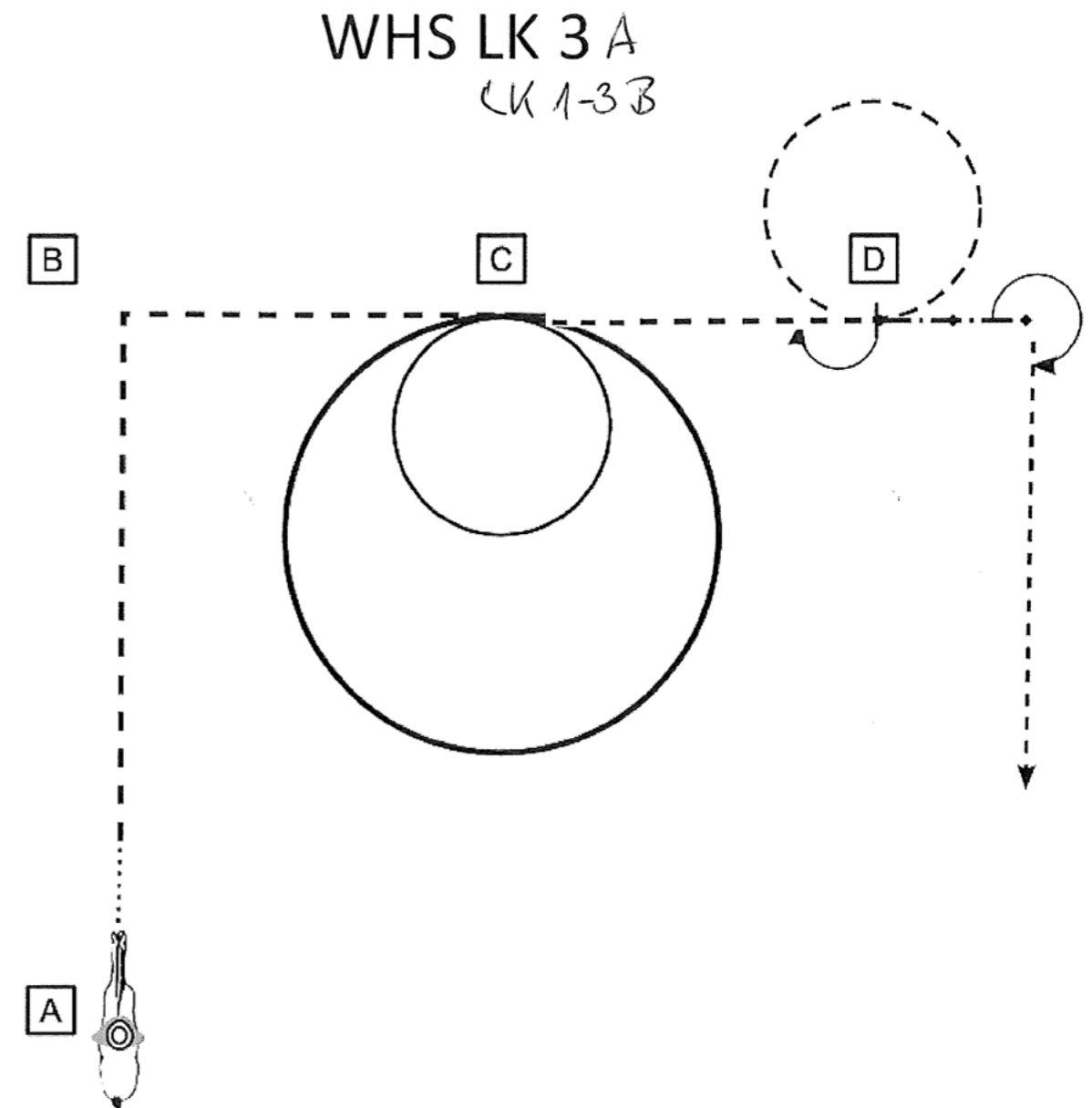

- Set up bei A
1. Walk, Jog bis C
  2. bei C Lope (RL) 2 Zirkel  
der erste Zirkel klein und langsam,  
der zweite Zirkel groß und schnell
  3. bei C Jog bis D, Stop
  4. 180° Turn (R)
  5. Jogzirkel um D - Stop
  6. Back Up
  7. 270° Turn (R), Jog out

# PATTERN

# PATTERN

#13 Showmanship at Halter LK 3 A, LK 1-3 B

#20 Showmanship at Halter LK 1/2 A

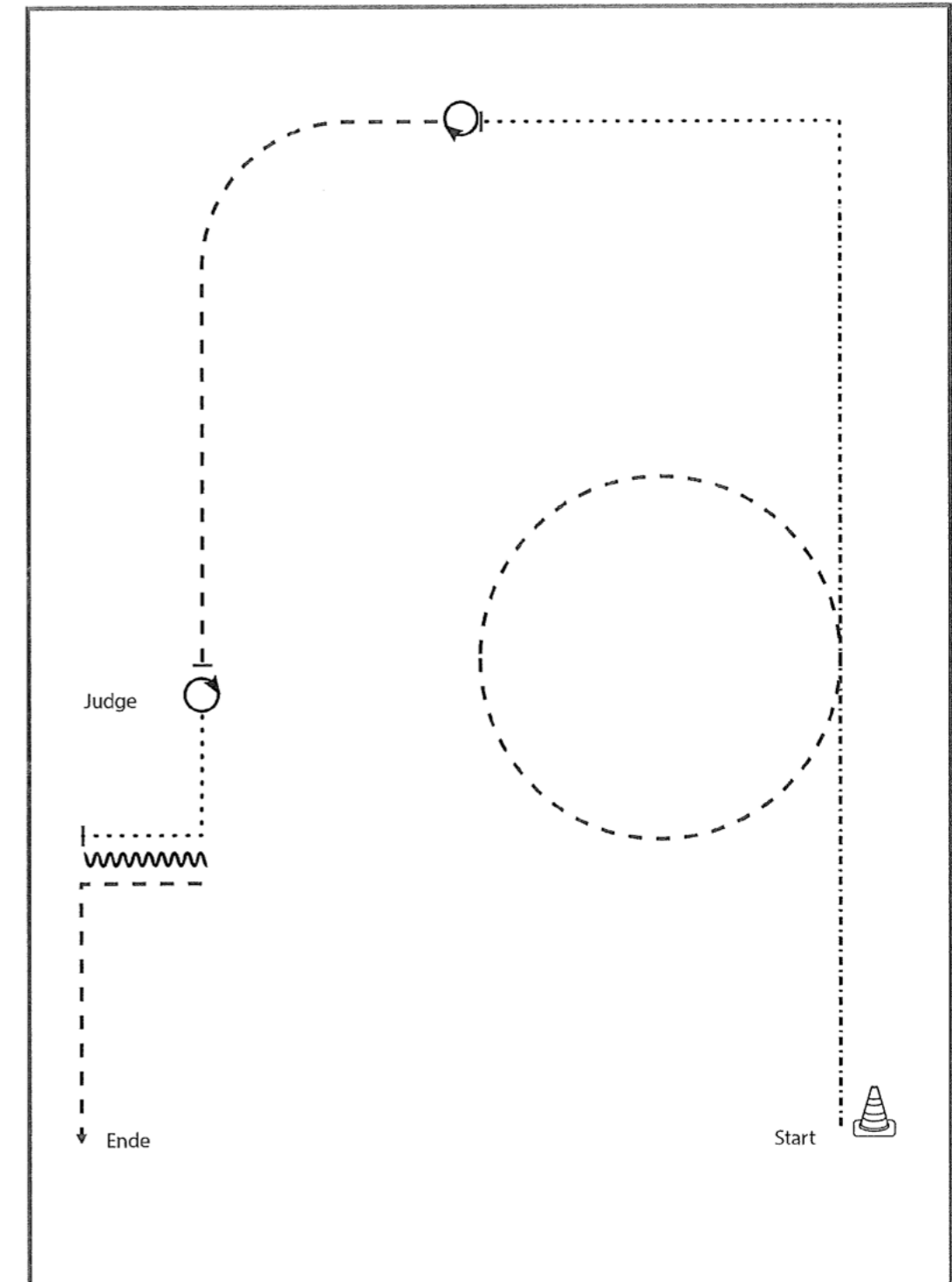
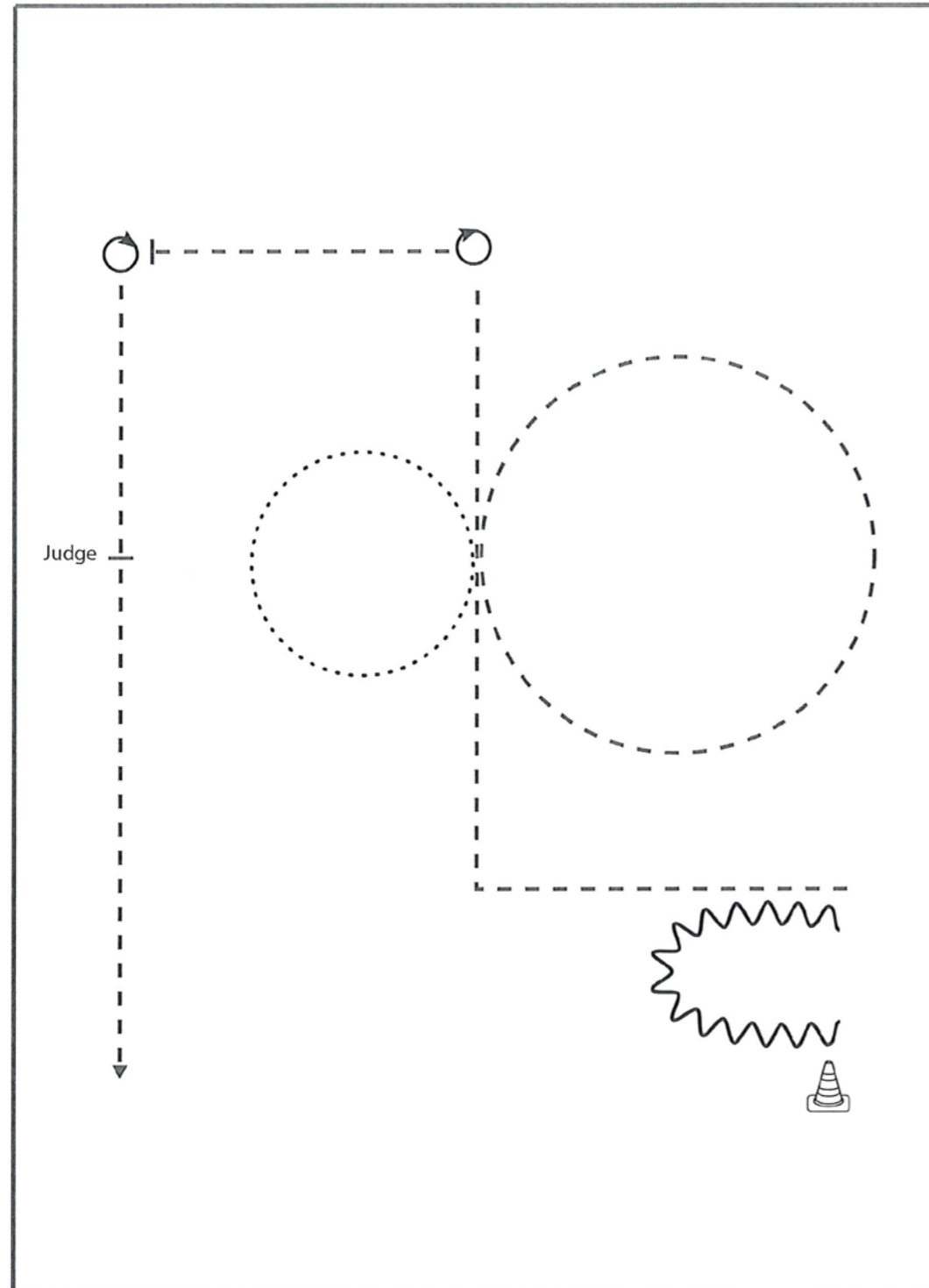

BE READY AT MARKER, SET UP

- 1) BACK UP
- 2) JOG CORNER, WALK SMALL CIRCLE TO THE LEFT
- 3) JOG SMALL CIRCLE TO THE RIGHT
- 4) STOP, TURN 270°
- 5) JOG
- 6) STOP, TURN 630°
- 7) JOG, STOP WITH THE HORSES SHOULDER ALIGNED WITH THE JUDGE
- 8) SET UP
- 9) INSPECTION
- 10) JOG OUT

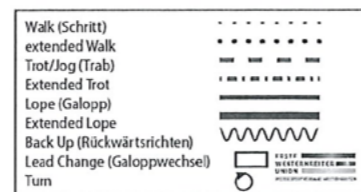

BE READY AT MARKER, SET UP

- 1) EXTENDED JOG
- 2) JOG SMALL CIRCLE
- 3) EXTENDED JOG, WALK CORNER
- 4) STOP, TURN 360°
- 5) JOG
- 6) STOP WITH THE HORSES HIP ALIGNED WITH THE JUDGE, TURN 360°
- 7) SET UP
- 8) INSPECTION
- 9) WALK CORNER, STOP, BACK UP (AT LEAST ONE HORSE LENGTH)
- 10) JOG CORNER, JOG OUT

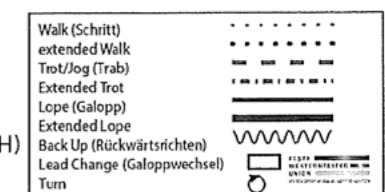



# PATTERN

## #15 Showmanship at Halter MLK 1/2 A/B

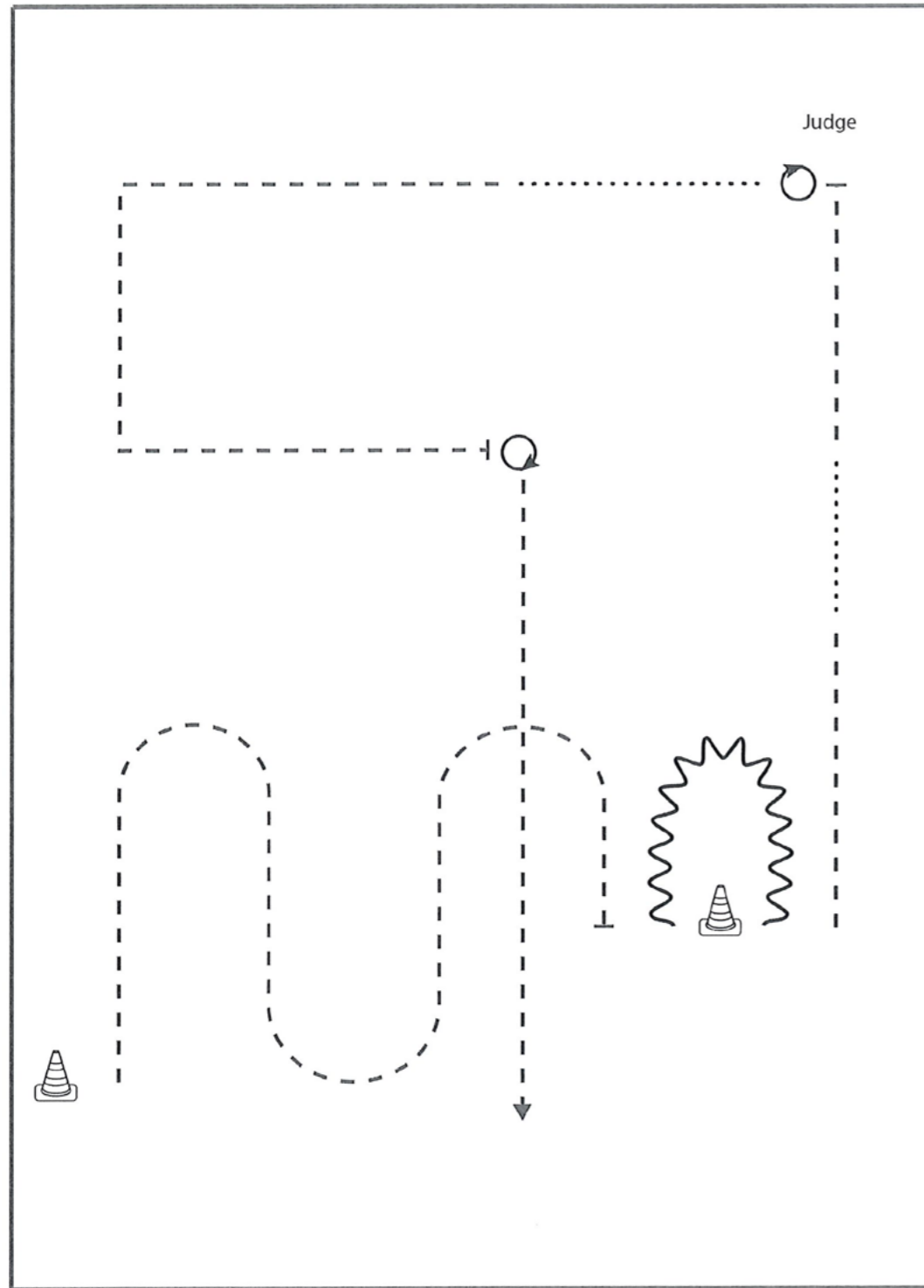

BE READY AT MARKER, SET UP

- 1) JOG, STOP
- 2) BACK UP
- 3) JOG, WALK
- 4) JOG, STOP
- 5) SET UP
- 6) INSPECTION
- 7) TURN 630°
- 8) WALK, JOG CORNERS
- 9) STOP, TURN 450°
- 10) JOG OUT

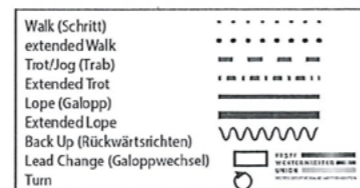

# PATTERN

## Pattern Trail - Set 6 - #4 - MLK 1/2 jun. MLK 1/2 B

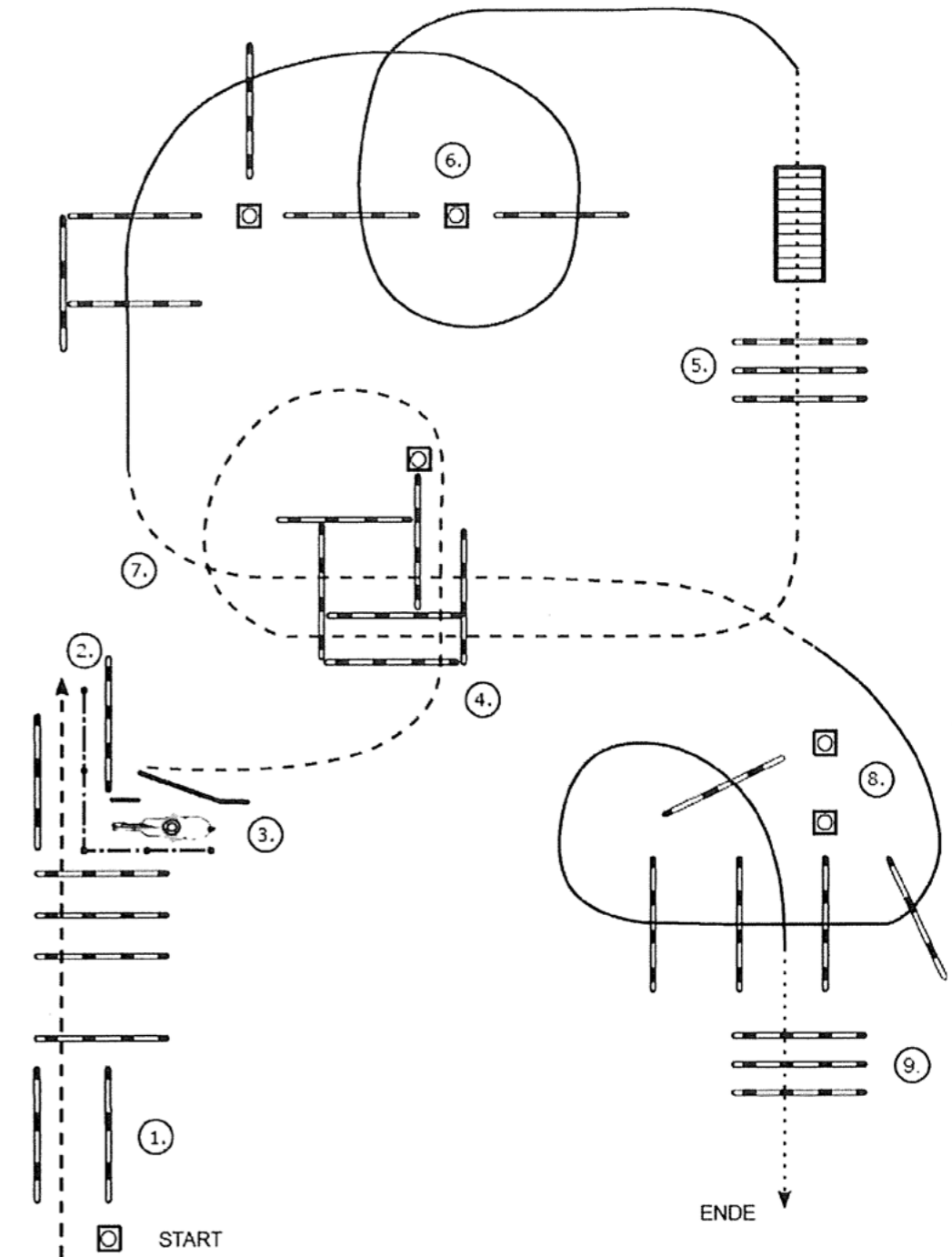

- (1) Jog over, Stop
- (2) Back up
- (3) Tor (rechte Hand), Jog out
- (4) Jog over
- (5) Stop/Übergang zum Walk, Walk over, Brücke
- (6) Lope over (Linksgalopp)
- (7) Jog over
- (8) Lope over (Rechtsgalopp)
- (9) Lope in, Stop/Übergang zum Walk, Walk over

# PATTERN

Pattern Trail - Set 6 - #2 - M LK 1/2 sen.

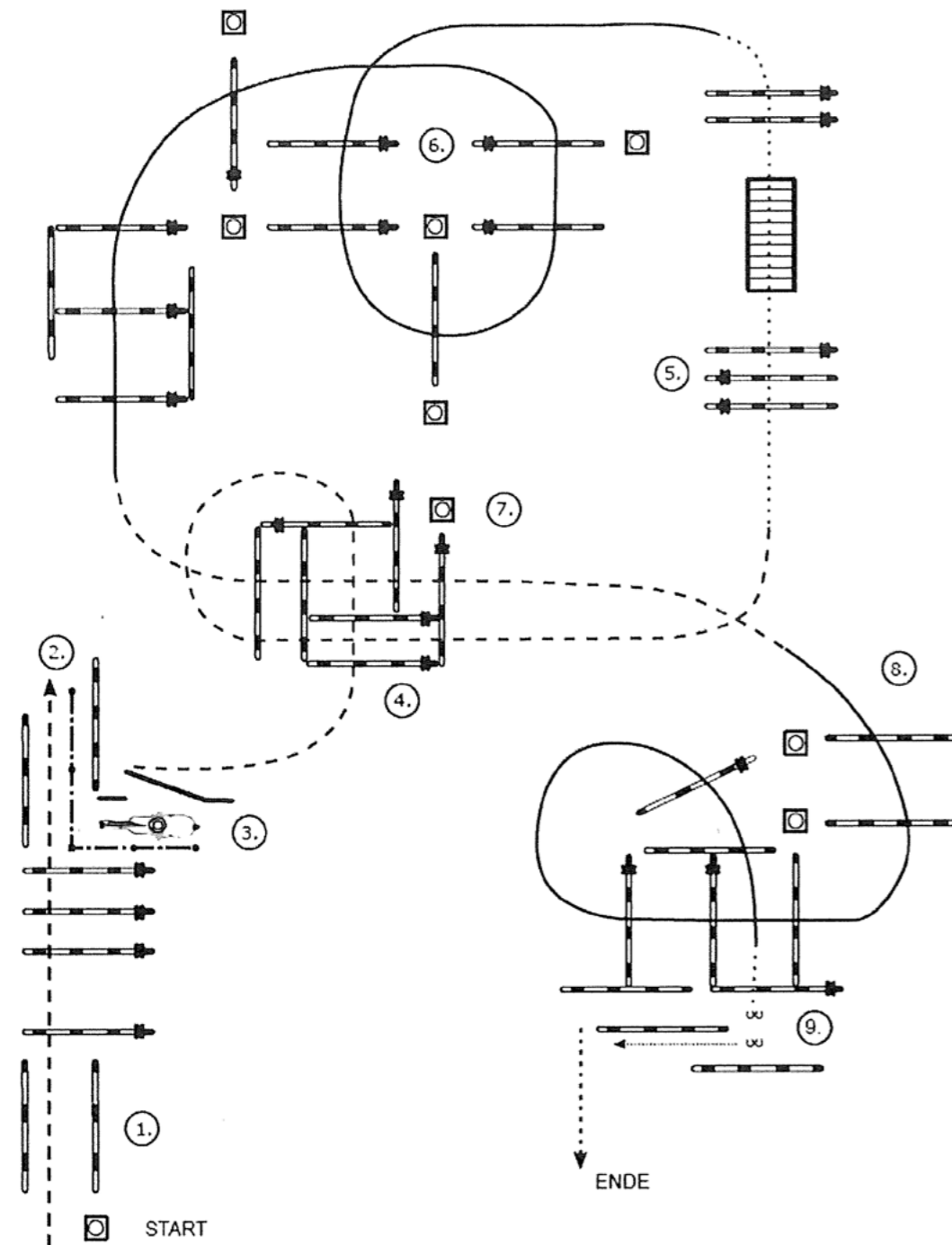

- (1) Jog over, Stop
- (2) Back up
- (3) Tor (rechte Hand), Jog out
- (4) Jog over
- (5) Stop/Übergang zum Walk, Walk over, Brücke, Walk over
- (6) Lope over (Linksgalopp)
- (7) Jog over
- (8) Lope over (Rechtsgalopp)
- (9) Lope in, Stop/Übergang zum Walk, Walk over, Seidepass 2. Stange

# PATTERN

Pattern W+S - #26 - M LK 1/2 A/B

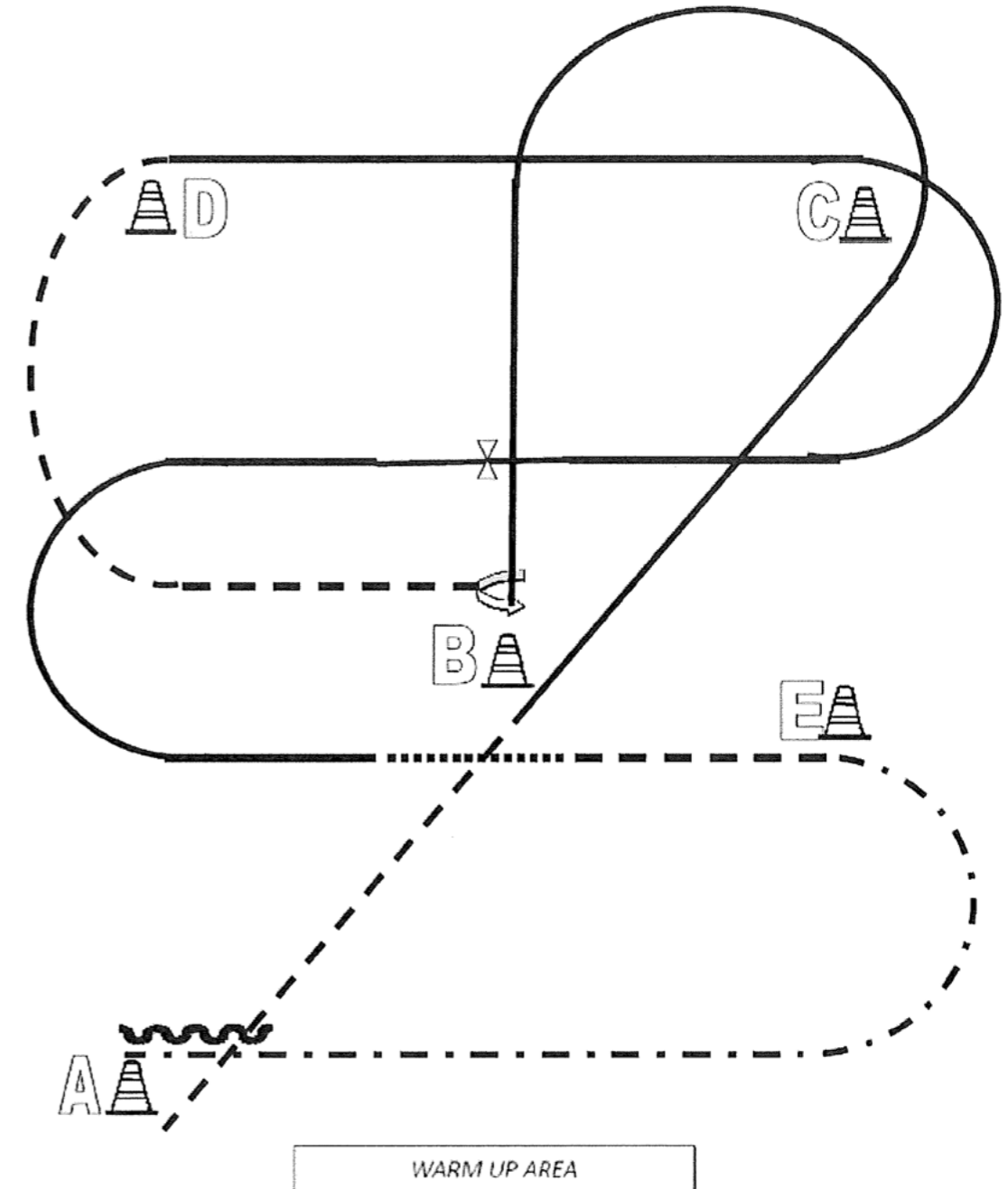

- (1) Beginnend aus dem Stand bei A im Jog zu B
- (2) Von B nach C Linksgalopp, um C und weiter zu B
- (3) Stop, 270° Turn links
- (4) Jog bis D
- (5) Bei D Rechtsgalopp
- (6) Höhe B Galoppwechsel (fliegend oder einfach)
- (7) Lope lins bis kurz vor B, durchparieren zum Walk
- (8) Jog bis E
- (9) Von E nach A Extended Jog
- (10) Bei A Stop, Back up mind. 1 Pferdelänge  
Im Walk in den Warm-Up-Bereich

# BASIS-SPONSOREN

# PATTERN



#11 LO Ranch Riding <sup>M</sup>sen. LK 1/2 Arenagröße min. 20 x 40 Meter  
A+B

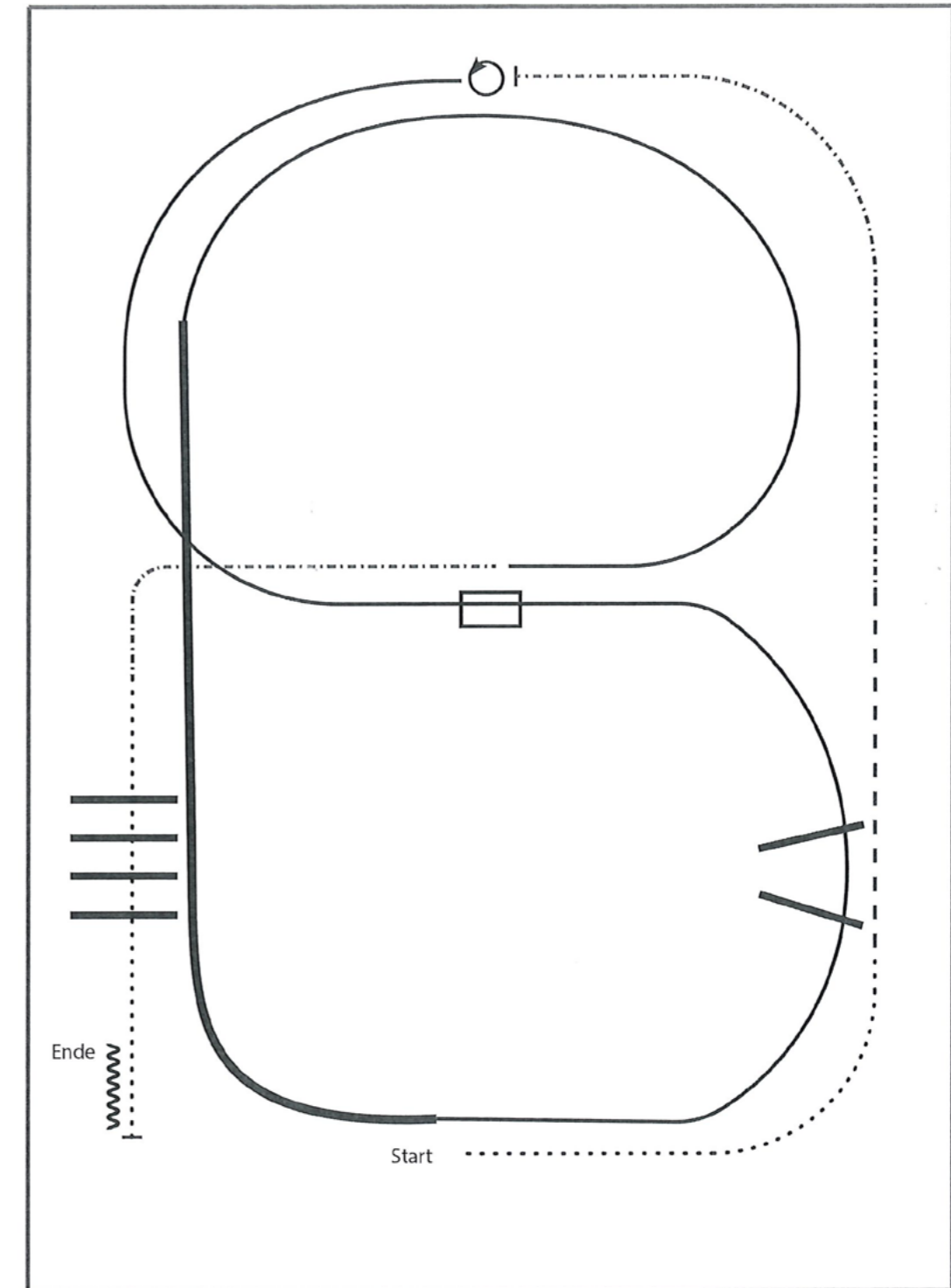

- 1) WALK
- 2) TROT
- 3) EXTENDED TROT, STOP
- 4) 360° TURN LEFT
- 5) LOPE LL
- 6) CHANGE LEADS (SIMPLE OR FLYING)
- 7) LOPE RL, LOPE OVER
- 8) EXTENDED LOPE RL
- 9) LOPE RL
- 10) EXTENDED TROT
- 11) WALK OVER
- 12) STOP, BACK UP

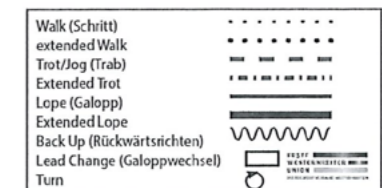

# PATTERN

#15 Ranch Riding Mjun. LK 1/2

Arenagröße min. 20 x 40 Meter

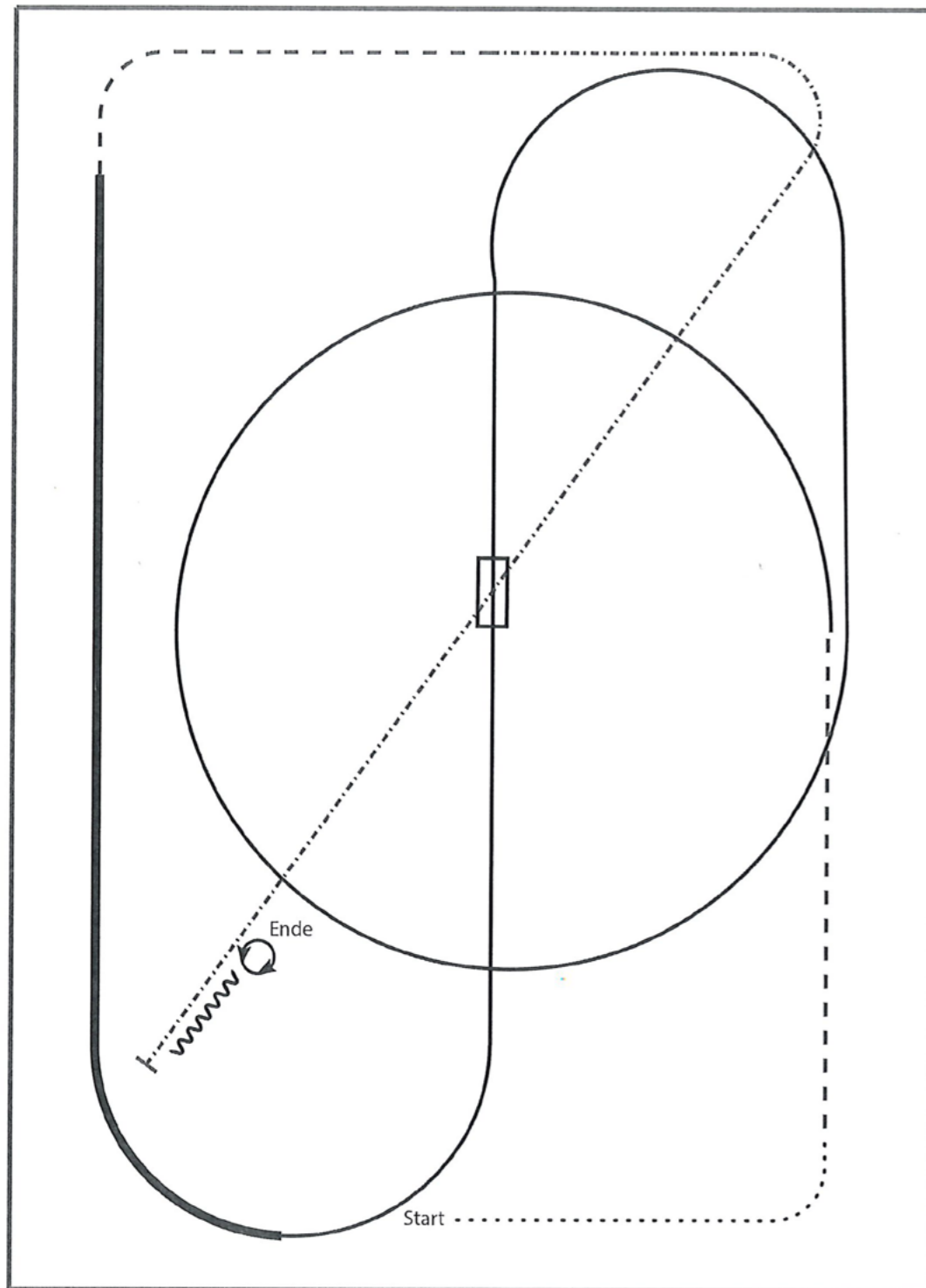

- 1) WALK
- 2) TROT
- 3) LOPE LL CIRCLE
- 4) CHANGE LEADS (SIMPLE OR FLYING)
- 5) LOPE RL
- 6) EXTENDED LOPE RL
- 7) TROT
- 8) EXTENDED TROT
- 9) STOP, BACK UP
- 10) 360° TURNS (EACH DIRECTION)

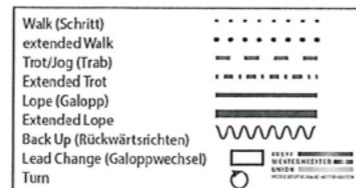

# PATTERN

Jungpferde Ranch Riding Pattern 3 (4.)

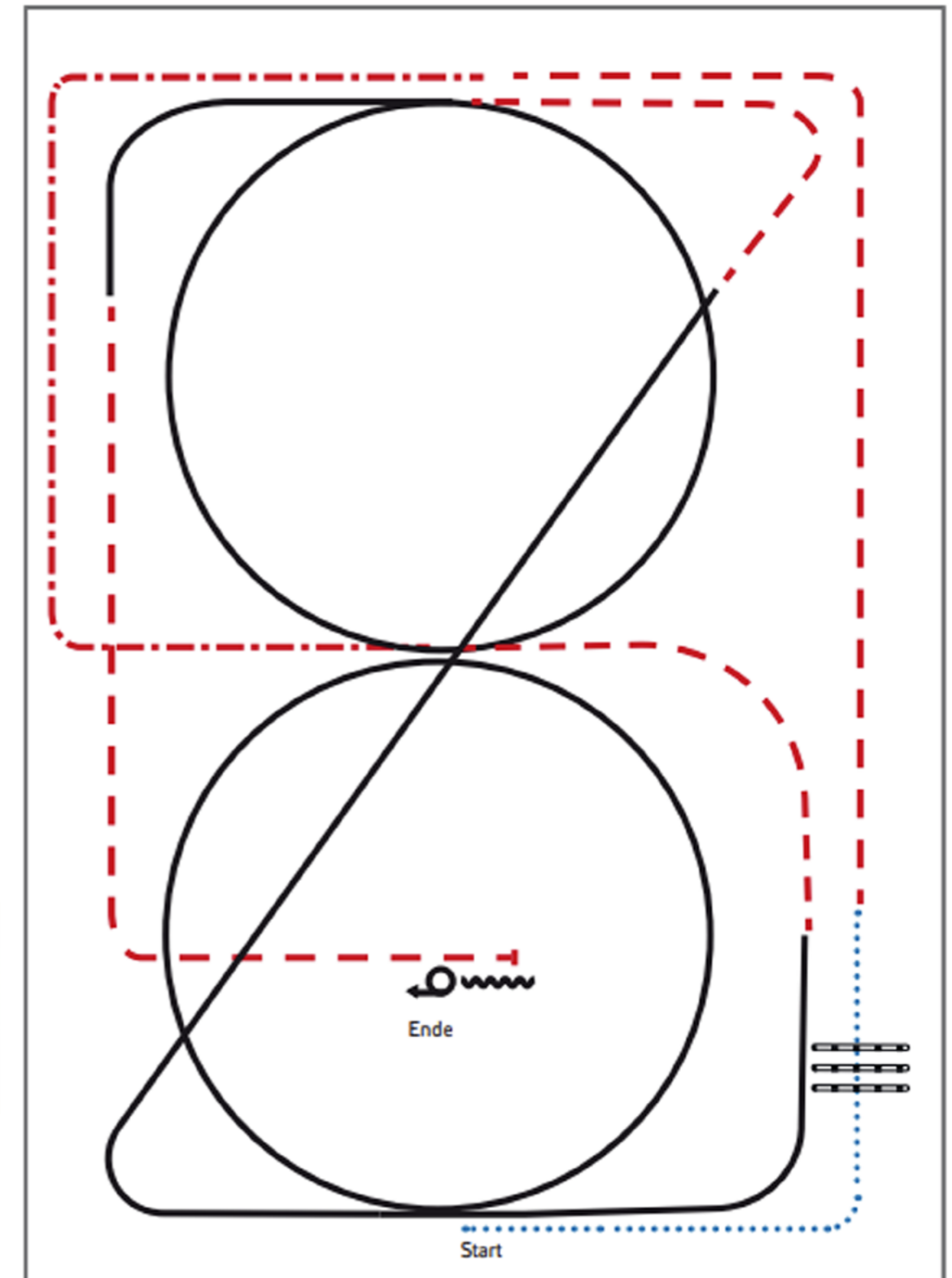

- 1) Walk, Walk over, Walk
- 2) Trot, extended Trot corners, Trot
- 3) Lope RL circle, Lope
- 4) Trot, Lope LL circle, Trot
- 5) Stop, Back up
- 6) Turn 360° left or right



# PATTERN

## Jungferde Ranch Riding Pattern 4 (5j.)

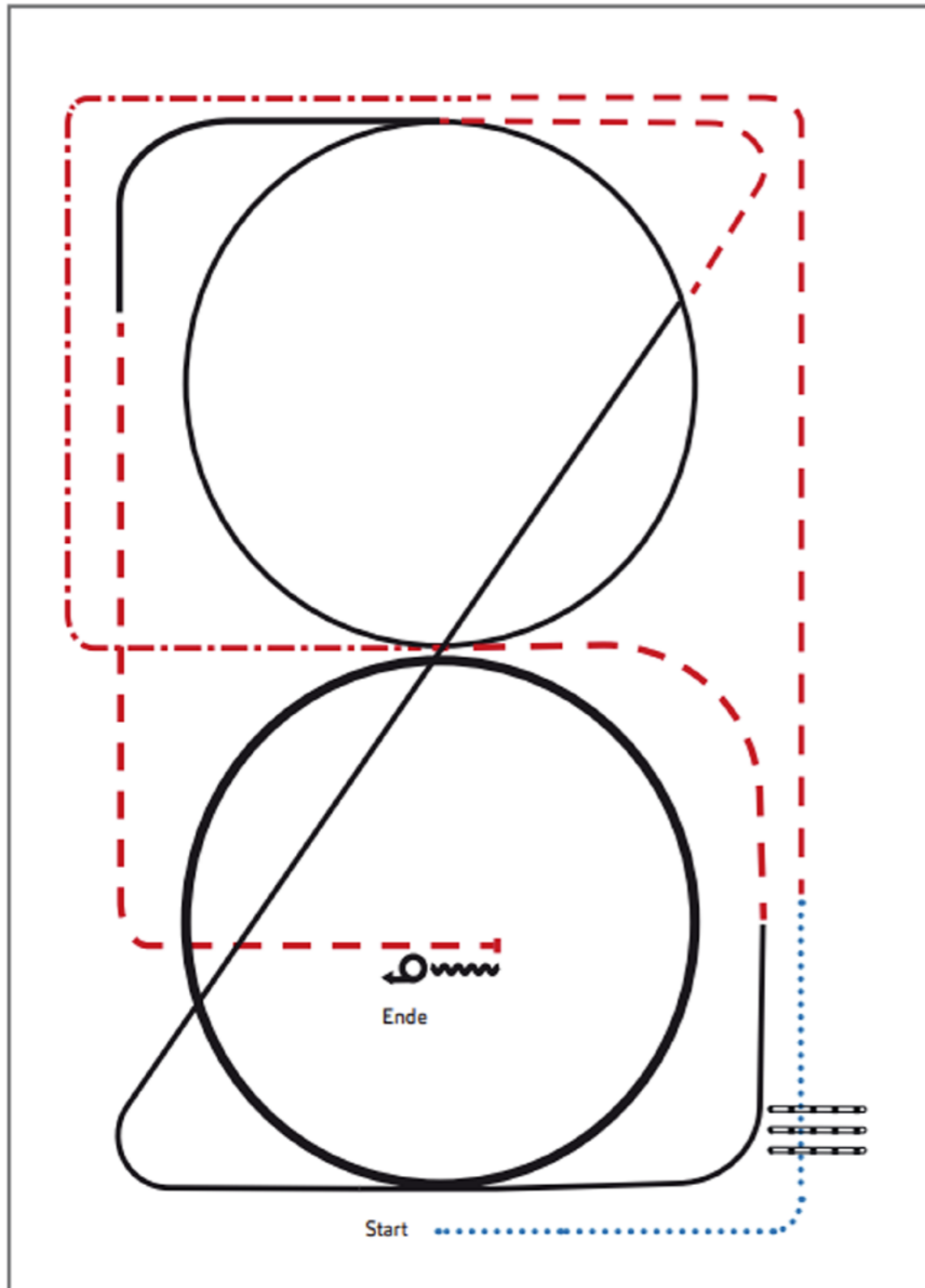

- 1) Walk, Walk over, Walk
- 2) Trot, extended Trot corners, Trot
- 3) Lope RL, extended Lope circle, Lope
- 4) Trot, Lope LL circle, Trot
- 5) Stop, Back Up
- 6) Turn 360° left or right



# PATTERN

## Jungferde Basis Pattern 2 (4j./5j.)

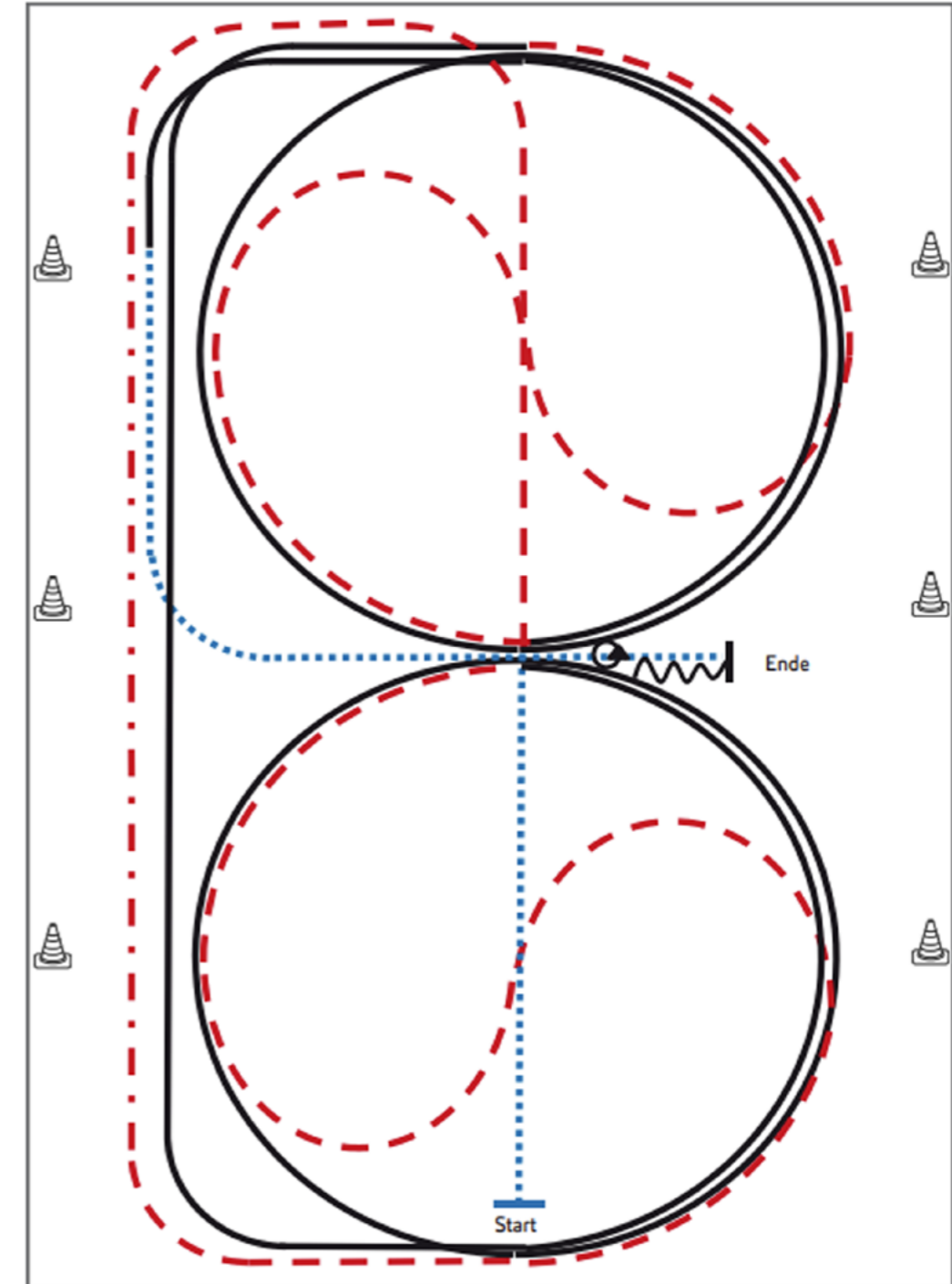

- 1) Schritt durch die Länge der Bahn, bei X Antraben, ganze Bahn, an der langen Seite Tritte verlängern (Leichttraben erlaubt)
- 2) Trab, Mitte der kurzen Seite auf dem Zirkel geritten, durch den Zirkel wechseln
- 3) Bei X Rechtsgalopp 1½ Zirkel, Mitte der kurzen Seite ganze Bahn
- 4) Mitte der kurzen Seite Trab auf dem Zirkel geritten, durch den Zirkel wechseln
- 5) Bei X Linksgalopp 1½ Zirkel, Mitte der kurzen Seite ganze Bahn
- 6) Nach Durchreiten der Ecke Schritt, Mitte der langen Seite abwenden, nach X Anhalten, Rückwärtsrichten bis X, HHW 360° links



Verharren, um das Ende der Prüfung anzuzeigen.

# PATTERN

Youngstars Challenge Pattern 3 (6j.) (Empfohlen für Hallen oder Plätze ab 20x40m)

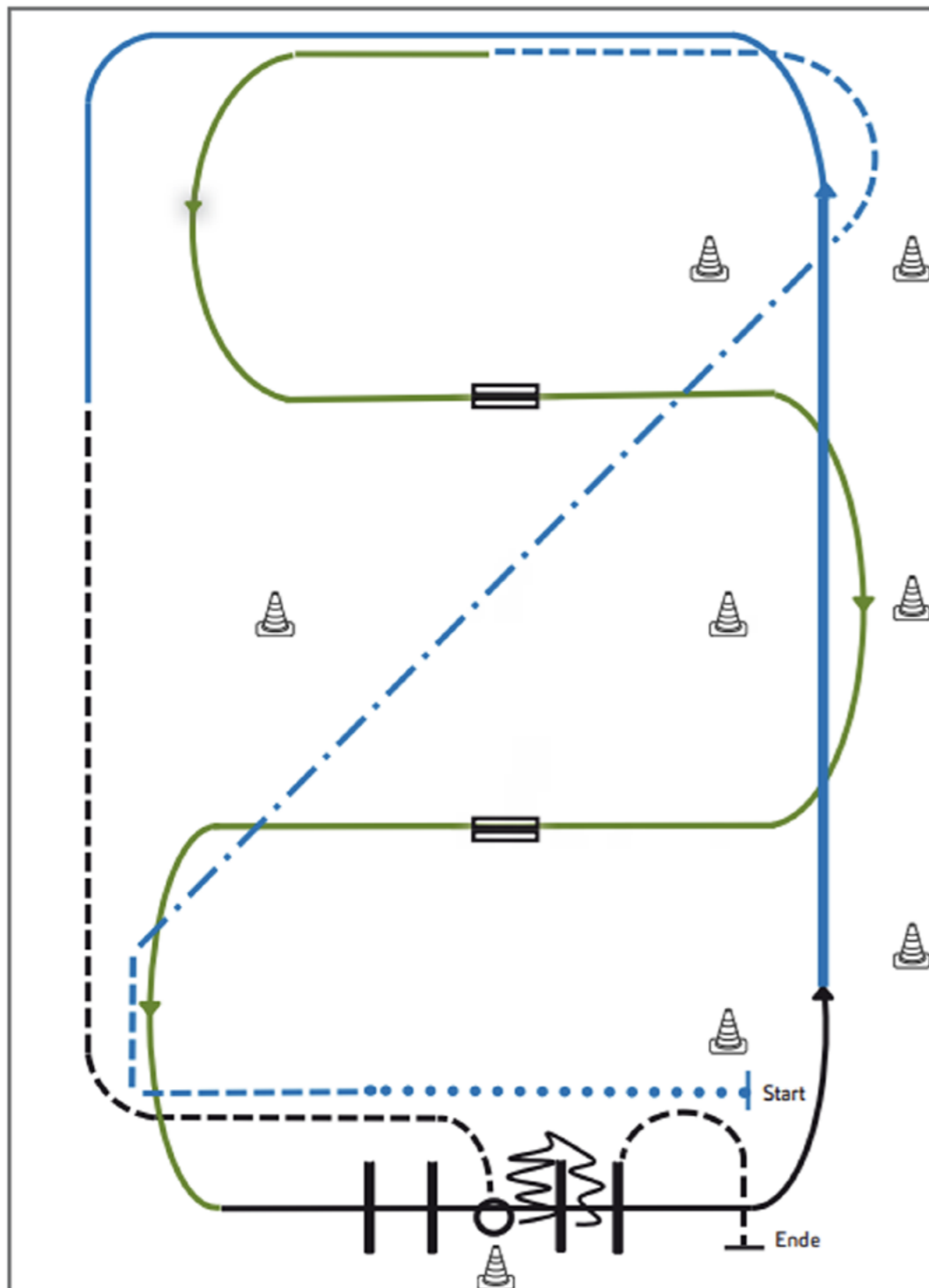

- 1) Extended Walk (RR)
- 2) Trot, Extended Trot, Trot (RR)
- 3) Galoppwechsel mit Seitenwechsel (WR)
- 4) Galoppwechsel mit Seitenwechsel (WR)
- 5) Lope over Linksgalopp (TH)
- 6) Extended Lope, Lope (RR)
- 7) Jog, Jog in, 360° Turn either way (TH)
- 8) Back up, Jog out (TH)



# PATTERN

Jungpferde Trail Pattern 1 (4j.)

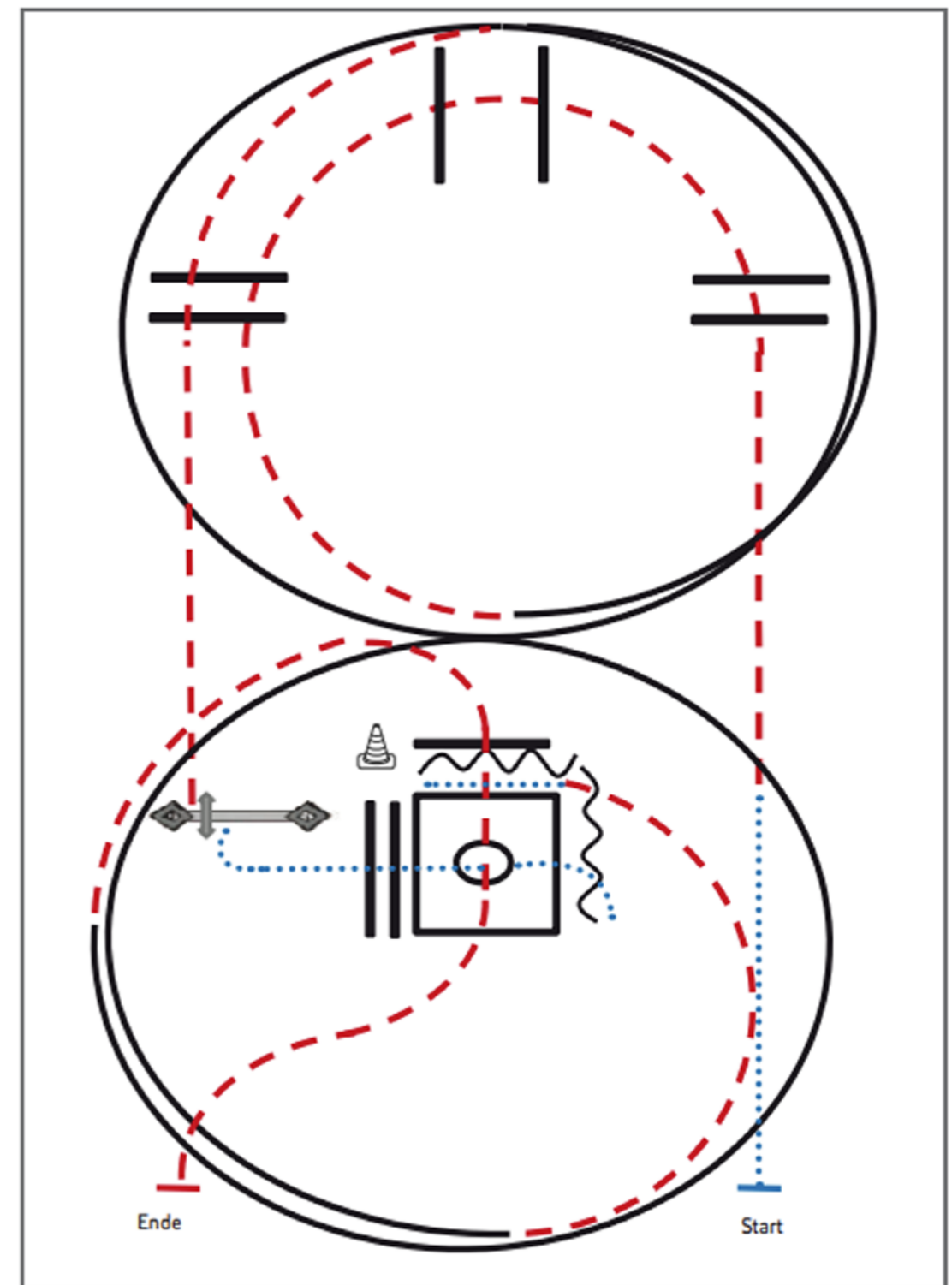

- 1) Schritt, Trab, Trabstangen (Abstand: 1,00 m/2,00 m/1,00 m)
- 2) Linksgalopp 1½ Zirkel, Trabstangen
- 3) Tor
- 4) Schritt, Schrittstangen (Abstand: 0,60 m), Box 360° (li. oder re.), Schritt
- 5) Rückwärtsrichten L (Abstand: 1,00 m), Schritt, Trab ½ Zirkel
- 6) Rechtsgalopp 1¼ Zirkel, Trabstangen, Anhalten



# BASIS-SPONSOREN



# PATTERN

Jungpferde Trail Pattern 2 (5j.)

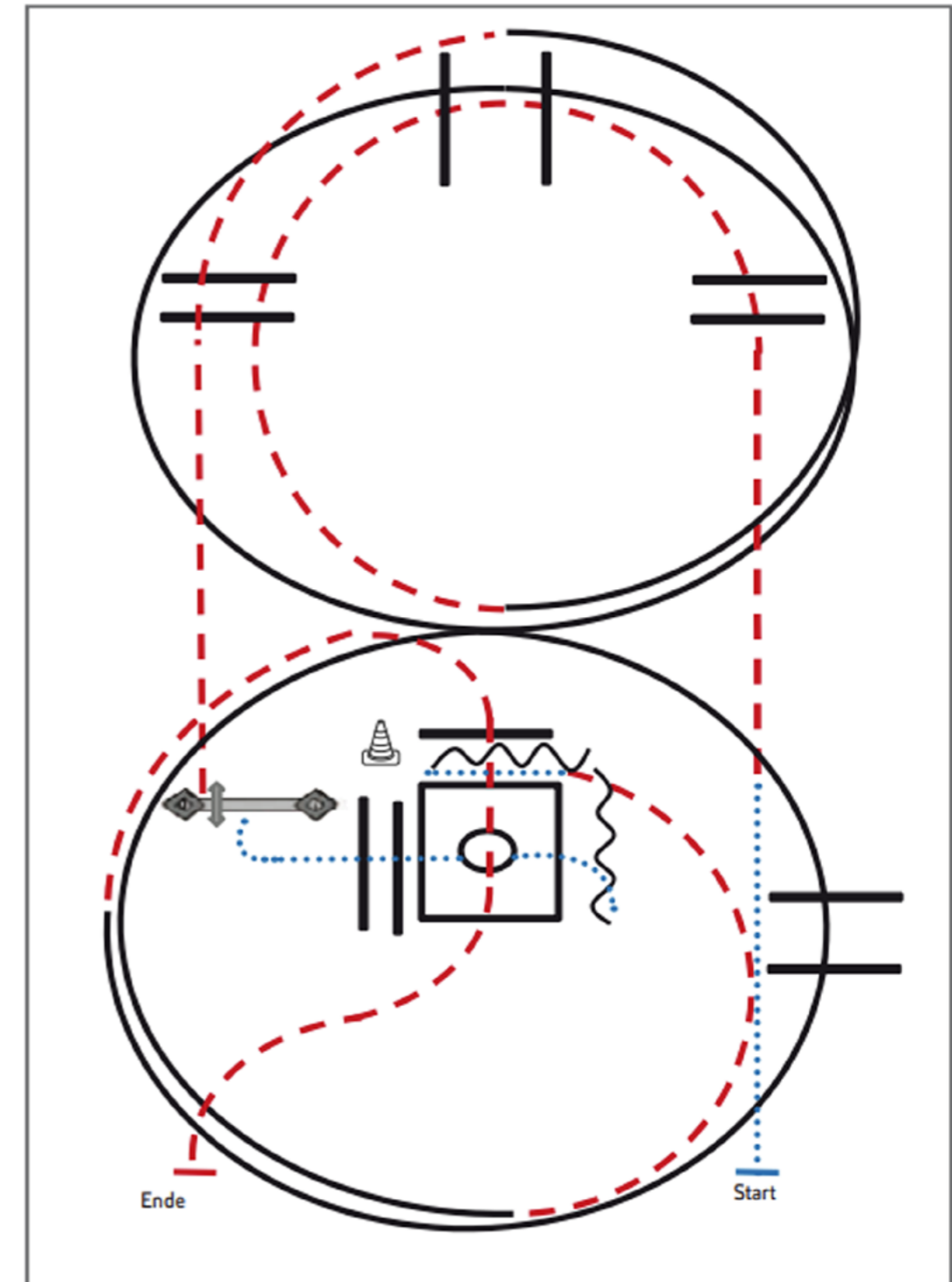

- 1) Schritt, Trab, Trabstangen (Abstand: 1,00 m/2,00 m/1,00 m)
- 2) Linksgalopp inkl. Galoppstangen, 1/2 Zirkel, Trabstangen
- 3) Tor
- 4) Schritt, Schrittstangen (Abstand: 0,60 m), Box 360° (li. oder re.), Schritt
- 5) Rückwärtsrichten L (Abstand: 1,00 m), Schritt, Trab 1/2 Zirkel
- 6) Rechtsgalopp 1/4 Zirkel inkl. Galoppstangen (Abstand: 2,00 m), Trabstangen, Anhalten

Legende:

Schritt	.....
Trab	- - - - -
Galopp	=====
Wechselzone	=====
Rückwärts	~~~~~

# PATTERN

Jungferde Reining Pattern 1 (4j./5j.)

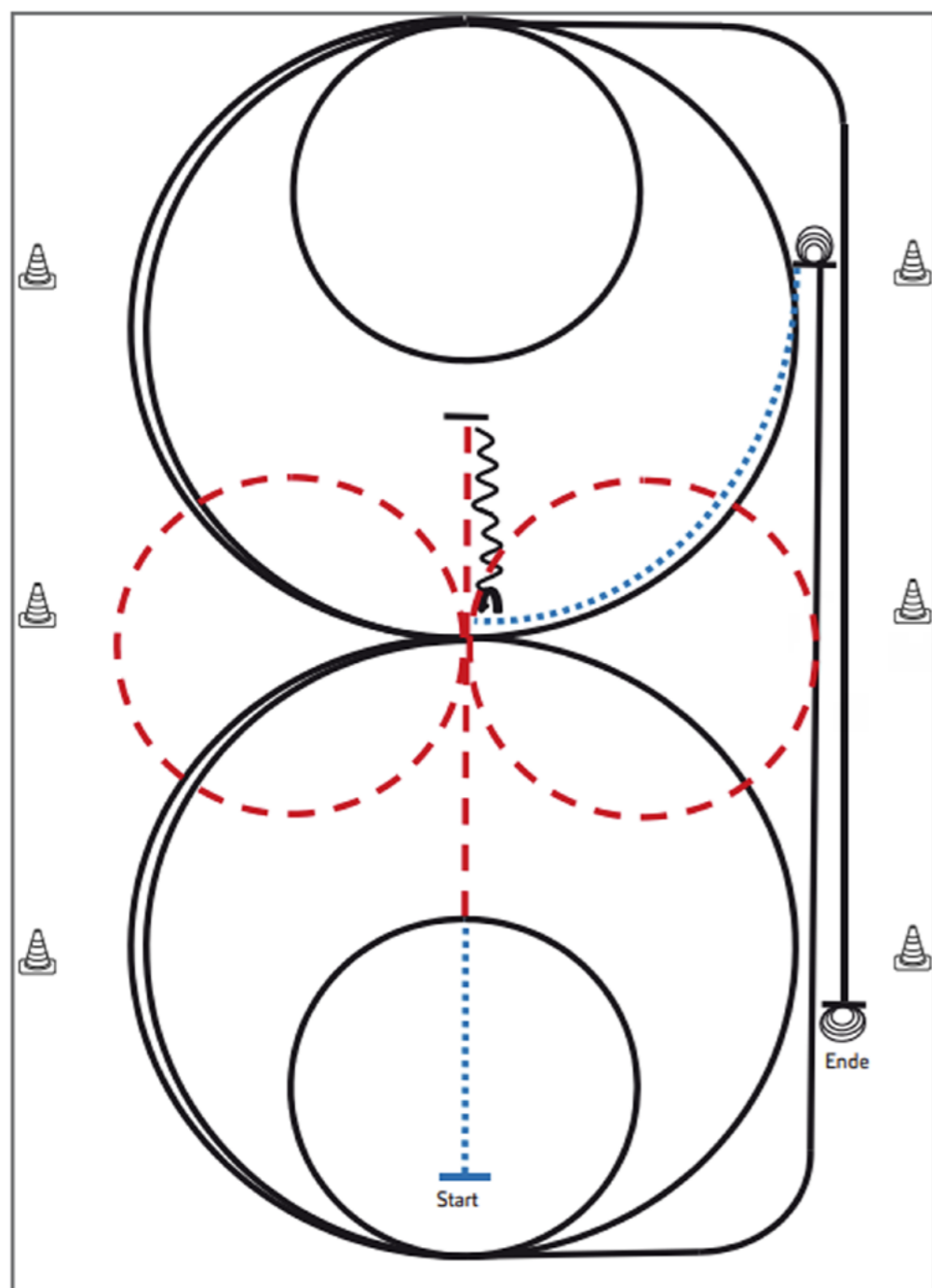

- 1) Schritt und Trab durch die Länge der Bahn, bei X eine Voltenacht (opt. li./re. beginnend), Trab
- 2) Stop hinter X, Rückwärtsrichten bis X, ¼ Turn **links**
- 3) 2½ Zirkel Galopp (**links**), 1½ groß, **2. klein** (alle Zirkel gleichbleibendes Tempo)
- 4) Run Down entlang der langen Seite, Sliding Stop mind. 6,00 m von der Bande entfernt hinter dem Endmarker
- 5) 3½ Spins **links**, Verharren
- 6) Schritt bis X, 2½ Zirkel Galopp (**rechts**), 1½ groß, **2. klein** (alle Zirkel gleichbleibendes Tempo)
- 7) Run Down entlang der langen Seite, Sliding Stop mind. 6,00 m von der Bande entfernt hinter dem **Endmarker**
- 8) 3½ Spins **rechts**, Verharren



Der Reiter muss das Kopfstück zur Gebisskontrolle vor dem Richter abnehmen.

# PATTERN

Reining Pattern 6

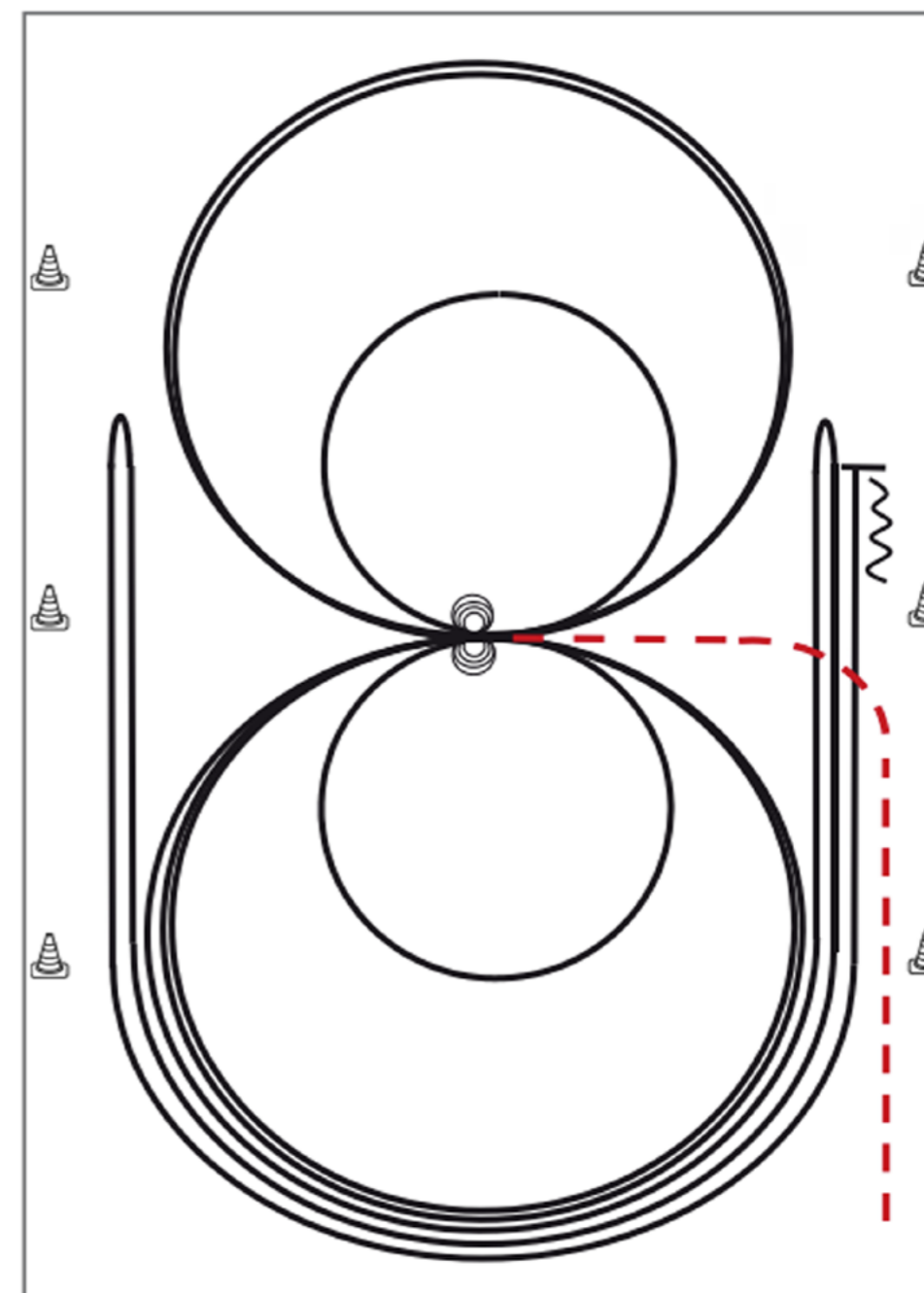

Im Trab zur Mitte der Bahn. Beginn der Aufgabe aus dem Schritt oder aus dem Stand.

- 1) 4 Spins **rechts**, Verharren
- 2) 4 Spins **links**, Verharren
- 3) 3 Zirkel Galopp (**links**), 1. + 2. groß und schnell, **3. klein** und langsam, Galoppwechsel bei X
- 4) 3 Zirkel Galopp (**rechts**), 1. + 2. groß und schnell, **3. klein** und langsam, Galoppwechsel bei X
- 5) Galopp (**links**) auf dem Zirkel, der nicht geschlossen wird, Run Down entlang der langen Seite, Sliding Stop mind. 6,00 m von der Bande entfernt hinter dem **Mittelmarker**, Rollback **rechts**, kein Verharren
- 6) Galopp (**rechts**) auf dem Zirkel, der nicht geschlossen wird, Run Down entlang der langen Seite, Sliding Stop mind. 6,00 m von der Bande entfernt hinter dem **Mittelmarker**, Rollback **links**, kein Verharren
- 7) Galopp (**links**) auf dem Zirkel, der nicht geschlossen wird, Run Down entlang der langen Seite, Sliding Stop mind. 6,00 m von der Bande entfernt hinter dem **Mittelmarker**, Rückwärtsrichten mind. 3,00 m, Verharren

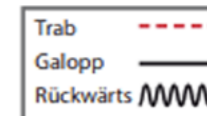

Der Reiter muss das Kopfstück zur Gebisskontrolle vor dem Richter abnehmen.



# PATTERN

Reining Pattern 8

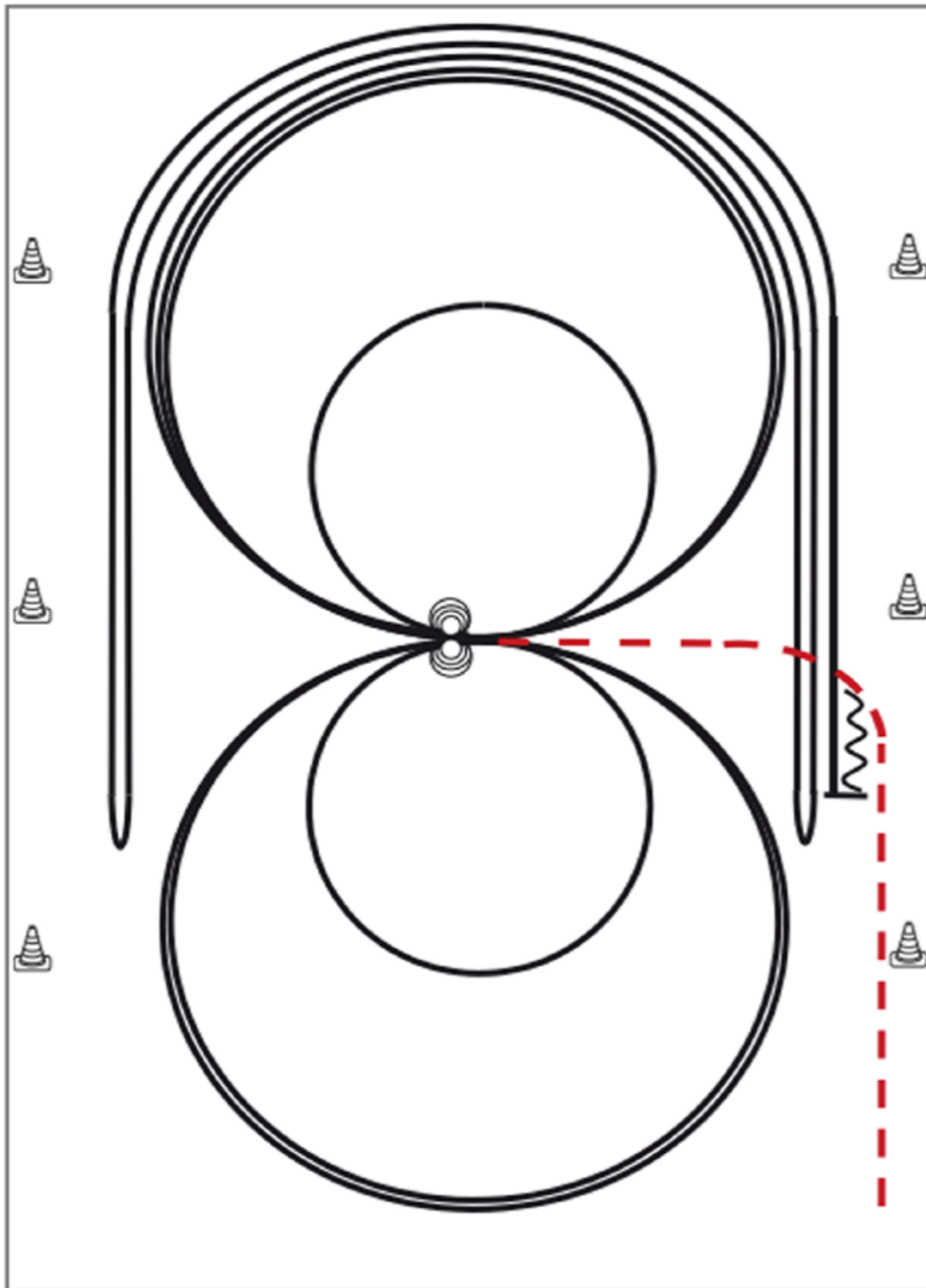

Im Trab zur Mitte der Bahn. Beginn der Aufgabe aus dem Schritt oder aus dem Stand.

- 1) 4 Spins **links**, Verharren
- 2) 4 Spins **rechts**, Verharren
- 3) 3 Zirkel Galopp (**rechts**), 1. groß und schnell, 2. **klein** und langsam, 3. groß und schnell, Galoppwechsel bei X
- 4) 3 Zirkel Galopp (**links**), 1. groß und schnell, 2. **klein** und langsam, 3. groß und schnell, Galoppwechsel bei X
- 5) Galopp (**rechts**) auf dem Zirkel, der nicht geschlossen wird, Run Down entlang der langen Seite, Sliding Stop mind. 6,00 m von der Bande entfernt hinter dem **Mittelmarker**, Rollback **links**, kein Verharren
- 6) Galopp (**links**) auf dem Zirkel, der nicht geschlossen wird, Run Down entlang der langen Seite, Sliding Stop mind. 6,00 m von der Bande entfernt hinter dem **Mittelmarker**, Rollback **rechts**, kein Verharren
- 7) Galopp (**rechts**) auf dem Zirkel, der nicht geschlossen wird, Run Down entlang der langen Seite, Sliding Stop mind. 6,00 m von der Bande entfernt hinter dem **Mittelmarker**, Rückwärtsrichten mind. 3,00 m, Verharren

Der Reiter muss das Kopfstück zur Gebisskontrolle vor dem Richter abnehmen.



# PATTERN

Reining Pattern 2

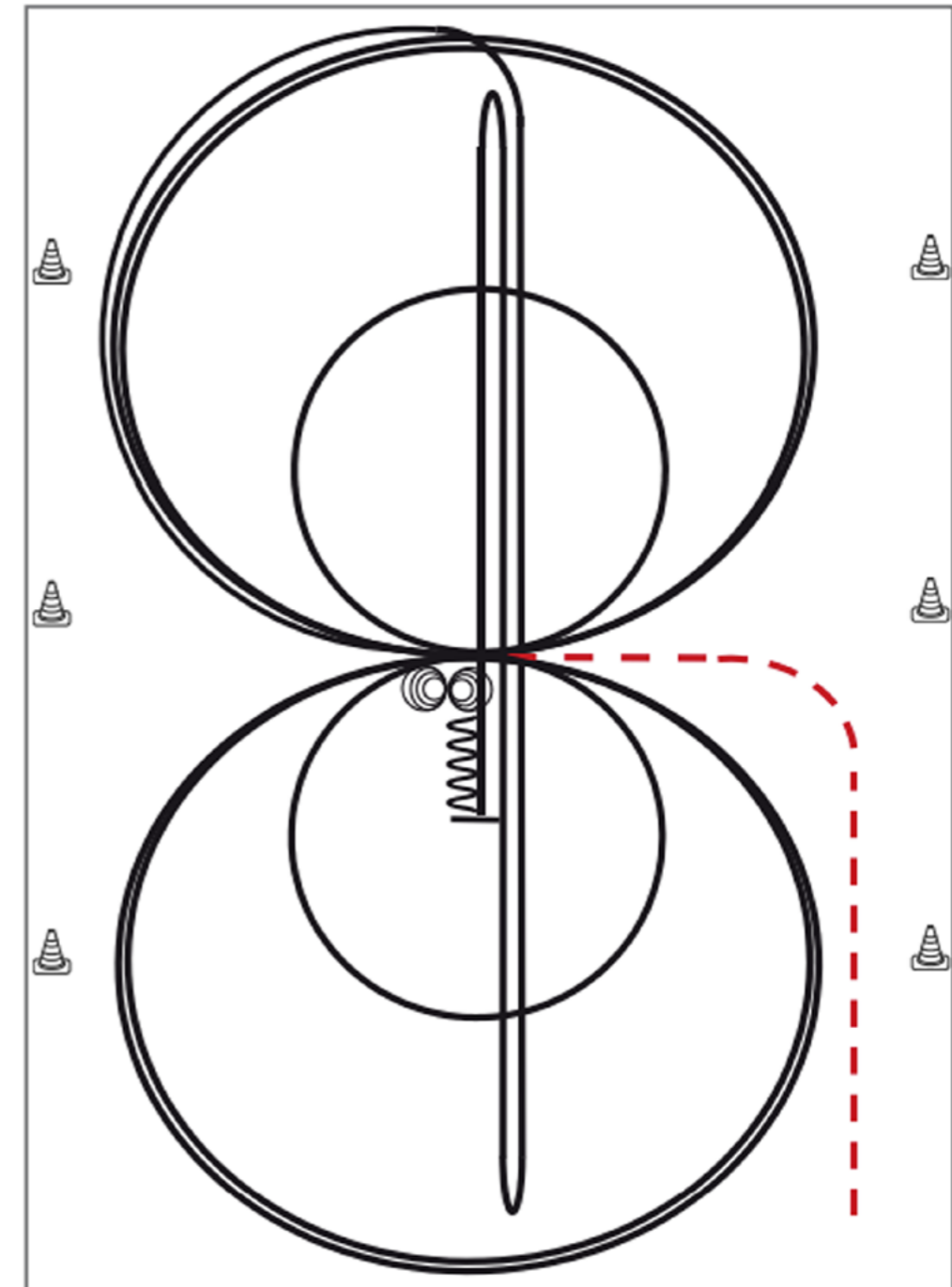

Im Trab zur Mitte der Bahn. Beginn der Aufgabe aus dem Schritt oder aus dem Stand.

- 1) 3 Zirkel Galopp (**rechts**), 1. **klein** und langsam, 2. + 3. groß und schnell, Galoppwechsel bei X
- 2) 3 Zirkel Galopp (**links**), 1. **klein** und langsam, 2. + 3. groß und schnell, Galoppwechsel bei X
- 3) Galopp (**rechts**) auf dem Zirkel, der nicht geschlossen wird, Run Down auf der Mittellinie, Sliding Stop hinter dem **Endmarker**, Rollback **rechts**, kein Verharren
- 4) Run Down auf der Mittellinie, Sliding Stop hinter dem **Endmarker**, Rollback **links**, kein Verharren
- 5) Run Down auf der Mittellinie, Sliding Stop hinter dem **Mittelmarker**, Rückwärtsrichten bis zur Mitte der Bahn oder mind. 3,00 m, Verharren
- 6) 4 Spins rechts, Verharren
- 7) 4 Spins links, Verharren

Der Reiter muss das Kopfstück zur Gebisskontrolle vor dem Richter abnehmen.



# PATTERN

Reining Pattern 10

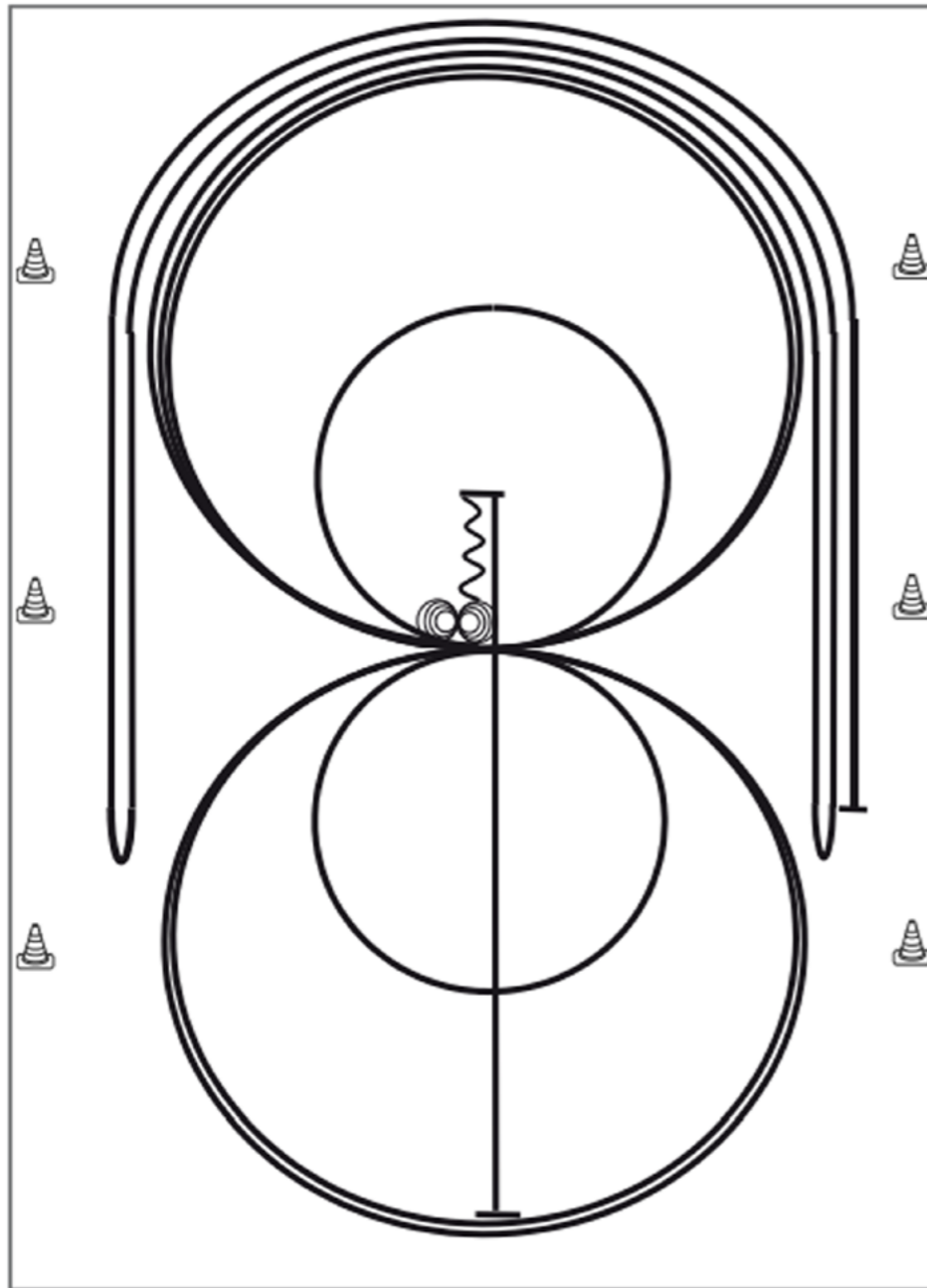

- 1) Run Down auf der Mittellinie, Sliding Stop hinter dem **Mittelmarker**, Rückwärtsrichten bis zur Mitte der Bahn oder mind. 3,00 m, Verharren
  - 2) 4 Spins **rechts**, Verharren
  - 3) 4¼ Spins **links**, Verharren
  - 4) 3 Zirkel Galopp (**rechts**), 1. + 2. groß und schnell, **3. klein** und langsam, Galoppwechsel bei X
  - 5) 3 Zirkel Galopp (**links**), **1. klein** und langsam, 2. + 3. groß und schnell, Galoppwechsel bei X
  - 6) Galopp (**rechts**) auf dem Zirkel, der nicht geschlossen wird, Run Down entlang der langen Seite, Sliding Stop mind. 6,00 m von der Bande entfernt hinter dem **Mittelmarker**, Rollback **links**, kein Verharren
  - 7) Galopp (**links**) auf dem Zirkel, der nicht geschlossen wird, Run Down entlang der langen Seite, Sliding Stop mind. 6,00 m von der Bande entfernt hinter dem **Mittelmarker**, Rollback **rechts**, kein Verharren
  - 8) Galopp (**rechts**) auf dem Zirkel, der nicht geschlossen wird, Run Down entlang der langen Seite, Sliding Stop mind. 6,00 m von der Bande entfernt hinter dem **Mittelmarker**, Verharren
- Der Reiter muss das Kopfstück zur Gebisskontrolle vor dem Richter abnehmen.



# PATTERN

Western Riding Pattern 3

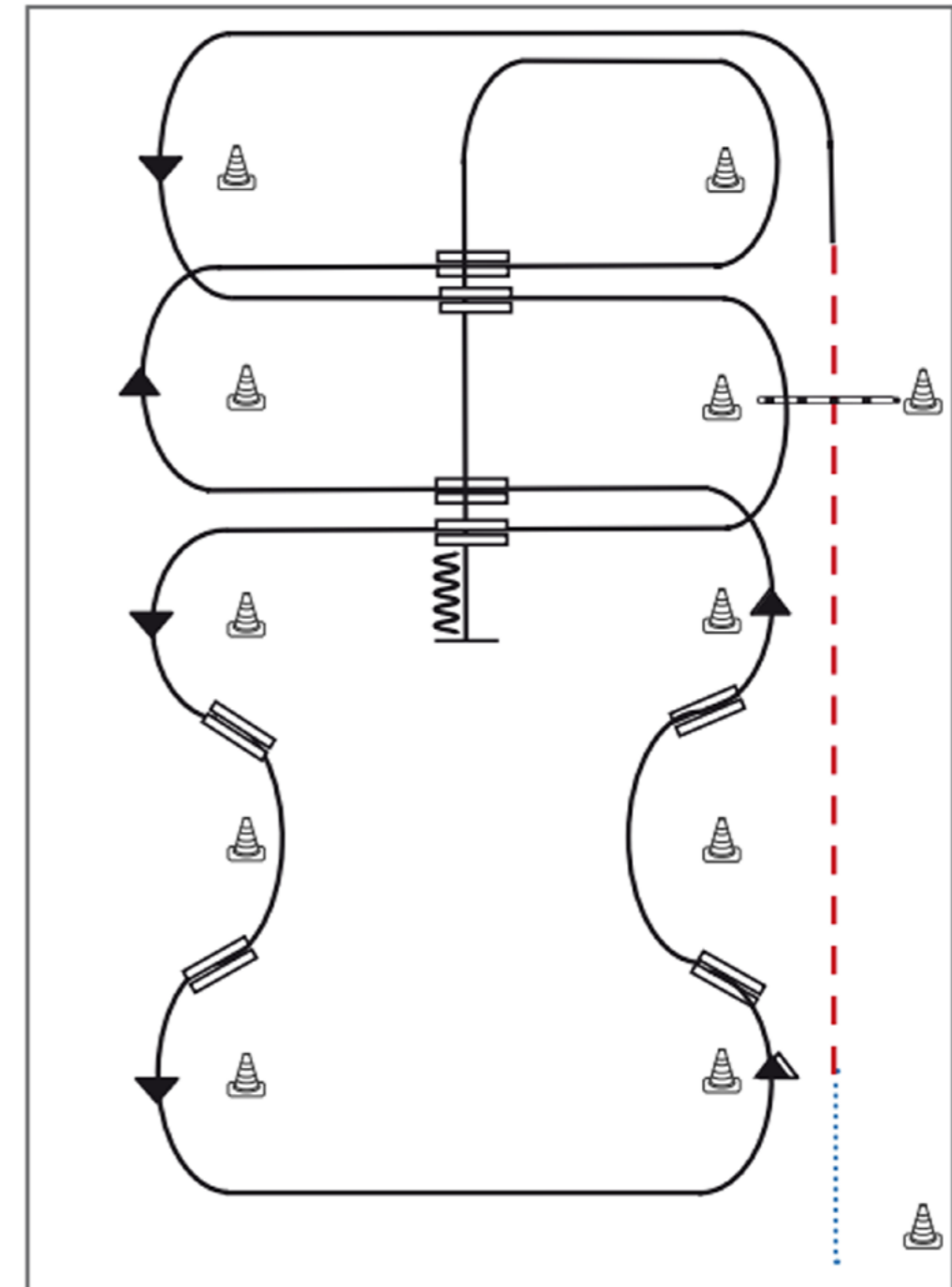

- 1) Schritt vom Start-Pylon zum ersten Marker, Übergang zum Trab, Trab über die Stange
- 2) Übergang zum Linksgalopp, Galopp an der kurzen Seite
- 3) 1. Galoppwechsel mit Seitenwechsel
- 4) Galopp über die Stange
- 5) 2. Galoppwechsel mit Seitenwechsel
- 6) 1. Galoppwechsel auf der Linie
- 7) 2. Galoppwechsel auf der Linie
- 8) 3. Galoppwechsel auf der Linie
- 9) 4. Galoppwechsel auf der Linie
- 10) 3. Galoppwechsel mit Seitenwechsel.
- 11) 4. Galoppwechsel mit Seitenwechsel
- 12) Mitte der kurzen Seite abwenden, Stop auf Höhe des Mittelmarkers, Rückwärtsrichten



# PATTERN

Western Riding Pattern 5 empfohlen für kleine Arenen

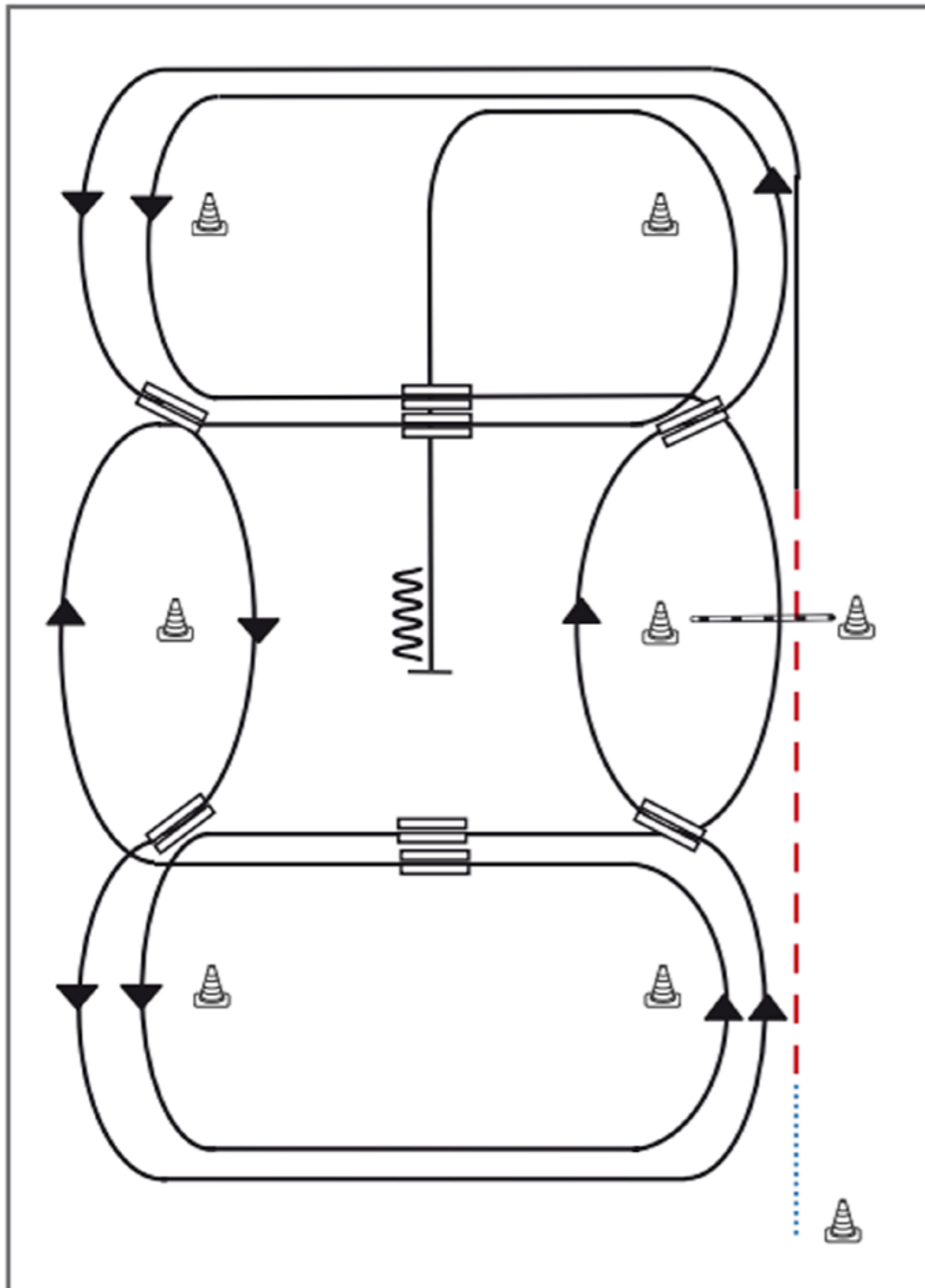

- 1) Schritt vom Start-Pylon zum ersten Marker, Übergang zum Trab, Trab über die Stange
- 2) Übergang zum Linksgalopp, Galopp an der kurzen Seite
- 3) 1. Galoppwechsel auf der Linie
- 4) 2. Galoppwechsel auf der Linie
- 5) 3. Galoppwechsel auf der Linie
- 6) 4. Galoppwechsel auf der Linie
- 7) 1. Galoppwechsel mit Seitenwechsel
- 8) Galopp über die Stange
- 9) 2. Galoppwechsel mit Seitenwechsel
- 10) 3. Galoppwechsel mit Seitenwechsel
- 11) 4. Galoppwechsel mit Seitenwechsel
- 12) Mitte der kurzen Seite abwenden, Stop auf Höhe des Mittelmarkers, Rückwärtsrichten



# PATTERN

Western Riding Pattern 11

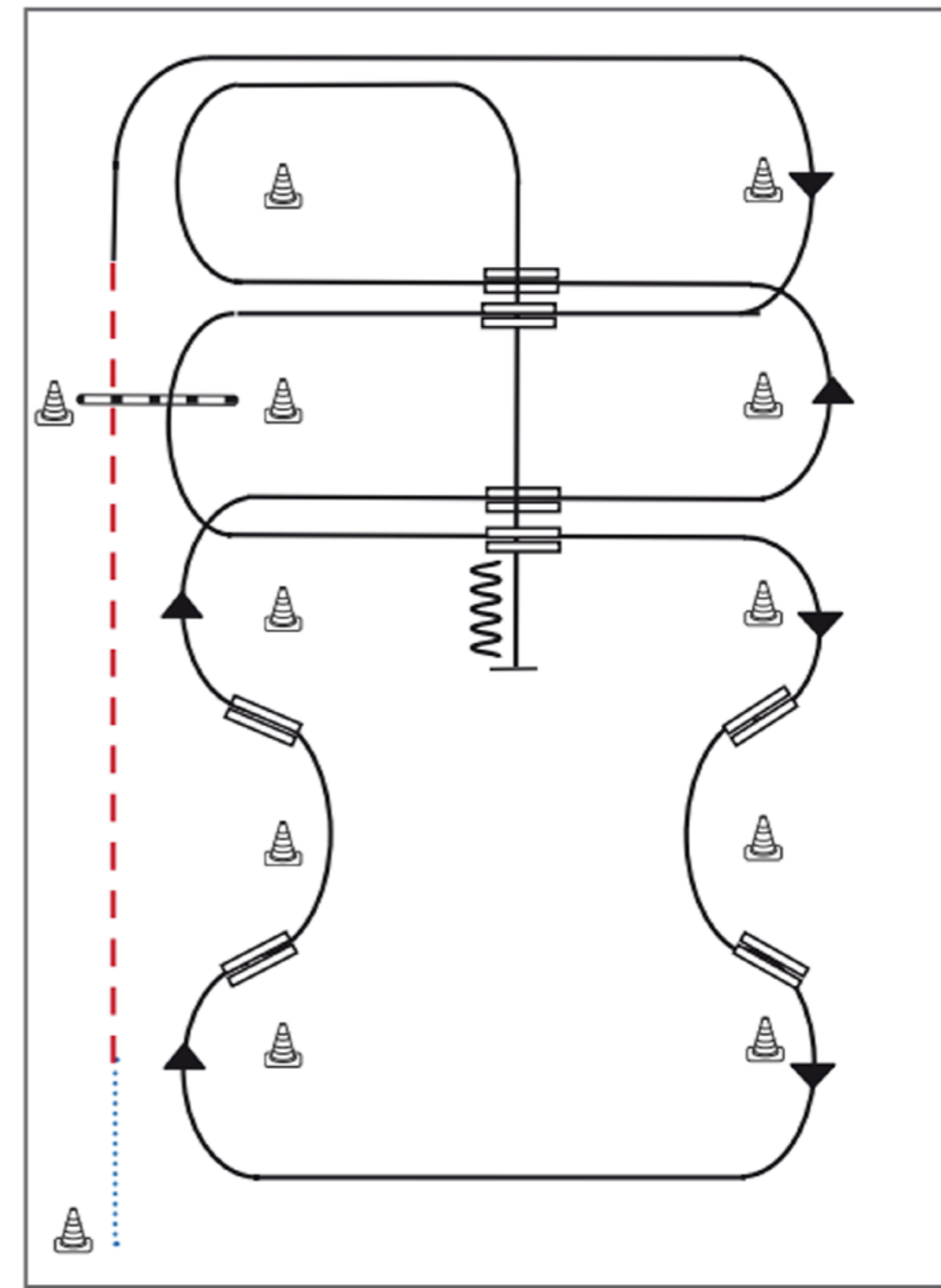

- 1) Schritt vom Start-Pylon zum ersten Marker, Übergang zum Trab, Trab über die Stange
- 2) Übergang zum Rechtsgalopp, Galopp an der kurzen Seite
- 3) 1. Galoppwechsel mit Seitenwechsel
- 4) Galopp über die Stange
- 5) 2. Galoppwechsel mit Seitenwechsel
- 6) 1. Galoppwechsel auf der Linie
- 7) 2. Galoppwechsel auf der Linie
- 8) 3. Galoppwechsel auf der Linie
- 9) 4. Galoppwechsel auf der Linie
- 10) 3. Galoppwechsel mit Seitenwechsel
- 11) 4. Galoppwechsel mit Seitenwechsel
- 12) Mitte der kurzen Seite abwenden, Stop auf Höhe des Mittelmarkers, Rückwärtsrichten



# PATTERN

Western Riding Pattern 13 (für Junior-Pferde)

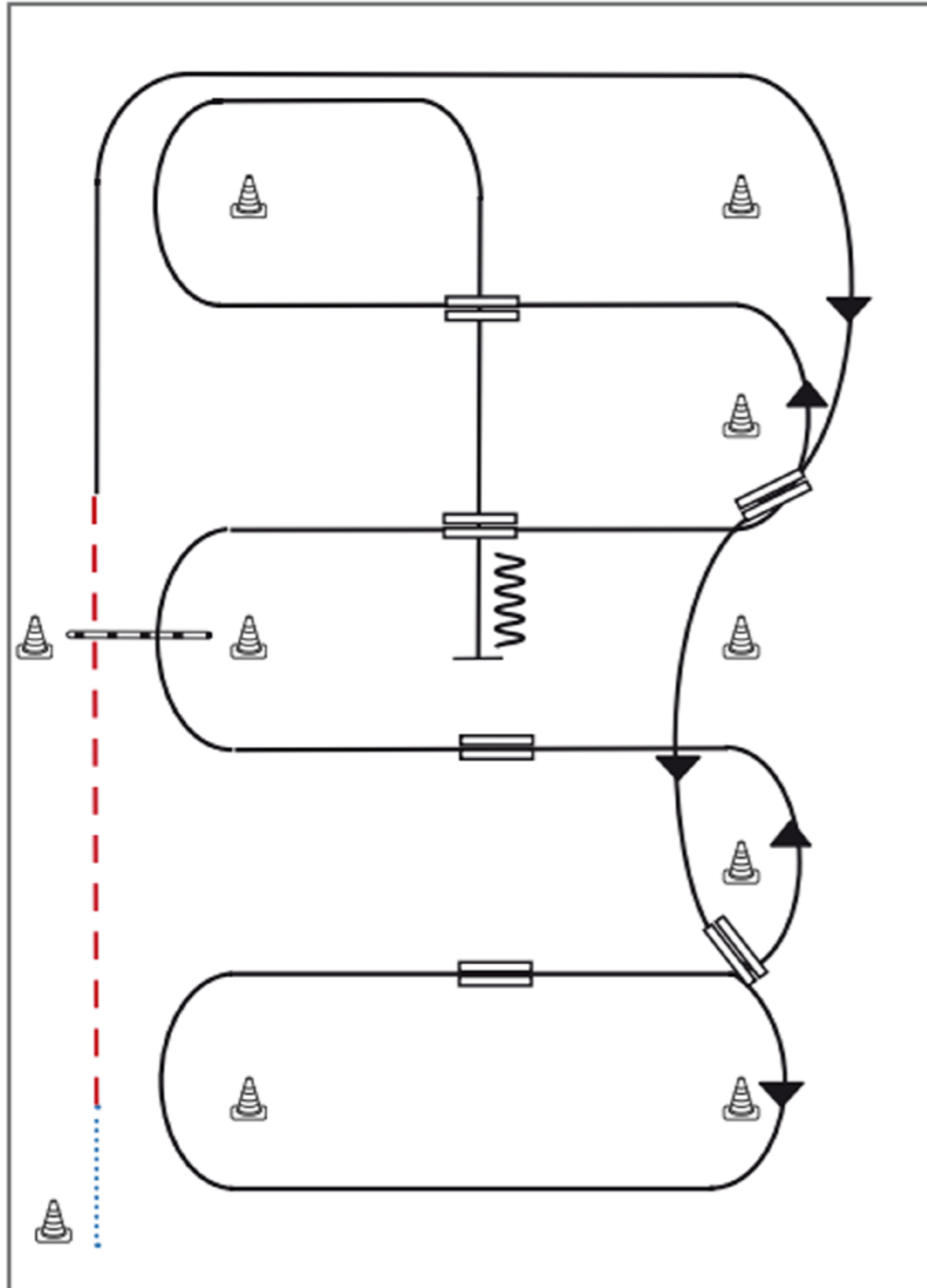

- 1) Schritt vom Start-Pylon zum ersten Marker, Übergang zum Trab, Trab über die Stange
- 2) Übergang zum Rechtsgalopp, Galopp an der kurzen Seite
- 3) 1. Galoppwechsel auf der Linie
- 4) 2. Galoppwechsel auf der Linie
- 5) 1. Galoppwechsel mit Seitenwechsel
- 6) 2. Galoppwechsel mit Seitenwechsel
- 7) Galopp über die Stange
- 8) 3. Galoppwechsel mit Seitenwechsel
- 9) 4. Galoppwechsel mit Seitenwechsel
- 10) Mitte der kurzen Seite abwenden, Stop auf Höhe des Mittelmarkers, Rückwärtsrichten



# PATTERN

Superhorse Pattern 1 (empfohlen für Hallen oder Plätze ab 20x40m)

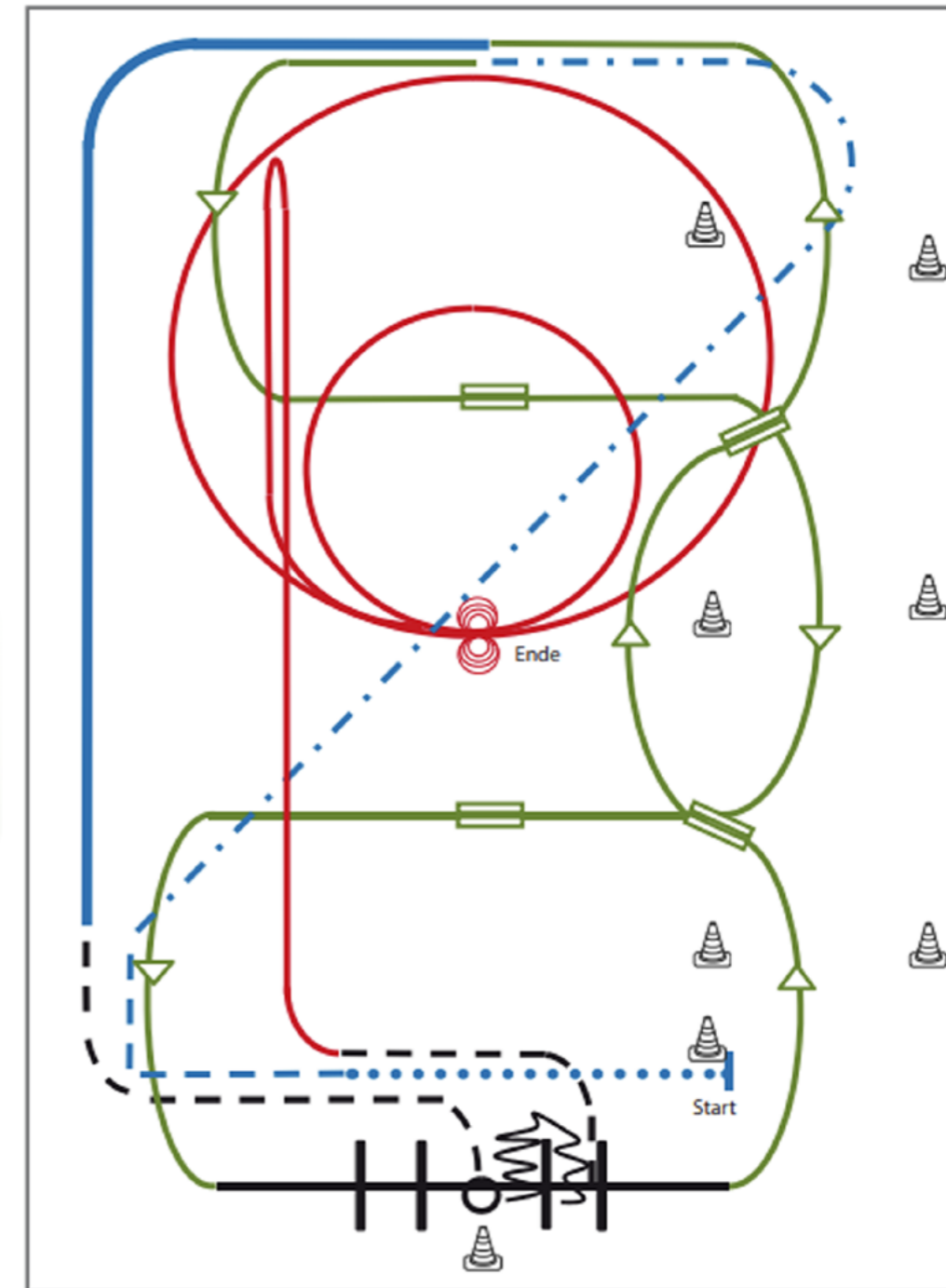

- 1) Extended Walk (RR)
- 2) Trot, Extended Trot (RR)
- 3) Galoppwechsel mit Seitenwechsel (WR)
- 4) Galoppwechsel mit Seitenwechsel (WR)
- 5) Lope over Linksgalopp (TH)
- 6) 2 Galoppwechsel auf der Linie (WR)
- 7) Extended Lope (RR)
- 8) Jog, Jog in, 360° Turn either way (TH)
- 9) Back up, Jog out (TH)
- 10) Rechtsgalopp, Run Down entlang der langen Seite, Sliding Stop mind. 6,00 m von der Bande entfernt hinter dem Mittelmarker, Rollback links, kein Verharren (RN)
- 11) 2 Zirkel Galopp (links), 1. groß und schnell, 2. klein und langsam, Stop bei X (RN)
- 12) 4 Spins links, 4 Spins rechts (RN)



# PATTERN

Superhorse Pattern 7 (empfohlen für Hallen oder Plätze ab 25x50m)

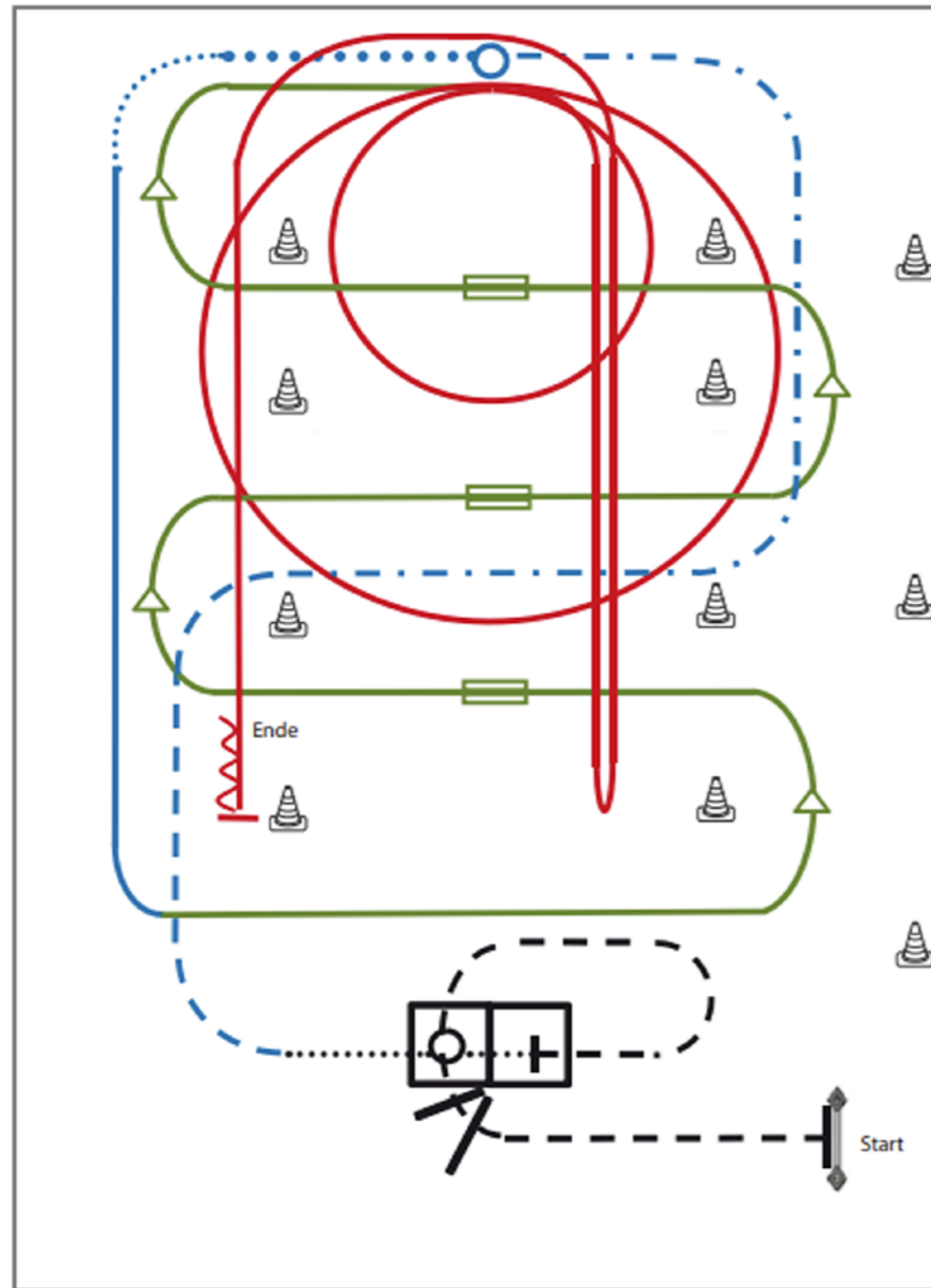

- 1) Seiltor über Stange (TH)
- 2) Jog over, Jog in, Stop (TH)
- 3) Walk in, 360° Turn either way, Walk out (TH)
- 4) Trot, Extended Trot, Stop (RR)
- 5) Turn 360° (each direction either way first) (RR)
- 6) Walk, Lope (RR)
- 7) Galoppwechsel mit Seitenwechsel (WR)
- 8) Galoppwechsel mit Seitenwechsel (WR)
- 9) Galoppwechsel mit Seitenwechsel (WR)
- 10) 2 Zirkel Galopp (rechts), 1. groß und schnell, 2. klein und langsam (RN)
- 11) Rechtsgalopp, Run Down entlang der langen Seite, Sliding Stop mind. 6,00 m von der Bande entfernt hinter dem Mittelmarker, Rollback links, kein Verharren (RN)
- 12) Galopp (links) auf dem Zirkel, der nicht geschlossen wird, Run Down entlang der langen Seite, Sliding Stop mind. 6,00 m von der Bande entfernt hinter dem Mittelmarker, Rückwärtsrichten mind. 3,00 m, Verharren (RN)

Legende:

Schritt	.....
Trab	----
Galopp	----
Wechselzone	▬▬▬
Rückwärts	~~~~~



Wir wünschen viel Erfolg!

# Landesmeisterschaft

## BADEN-WÜRTTEMBERG

DIE VORSTANDSCHAFT DER EWU BADEN-WÜRTTEMBERG